

AUDIO OSCILLATORS

**AUDIO SIGNAL
GENERATORS**

**VACUUM TUBE
VOLTMETERS**

UHF SIGNAL GENERATORS

FREQUENCY STANDARDS

**SQUARE WAVE
GENERATORS**

WAVE ANALYZERS

DISTORTION ANALYZERS

AMPLIFIERS

ATTENUATORS

**ELECTRONIC
FREQUENCY METERS**

**FM BROADCAST
MONITORS**

**REGULATED
POWER SUPPLIES**

**ELECTRONIC
TACHOMETERS**

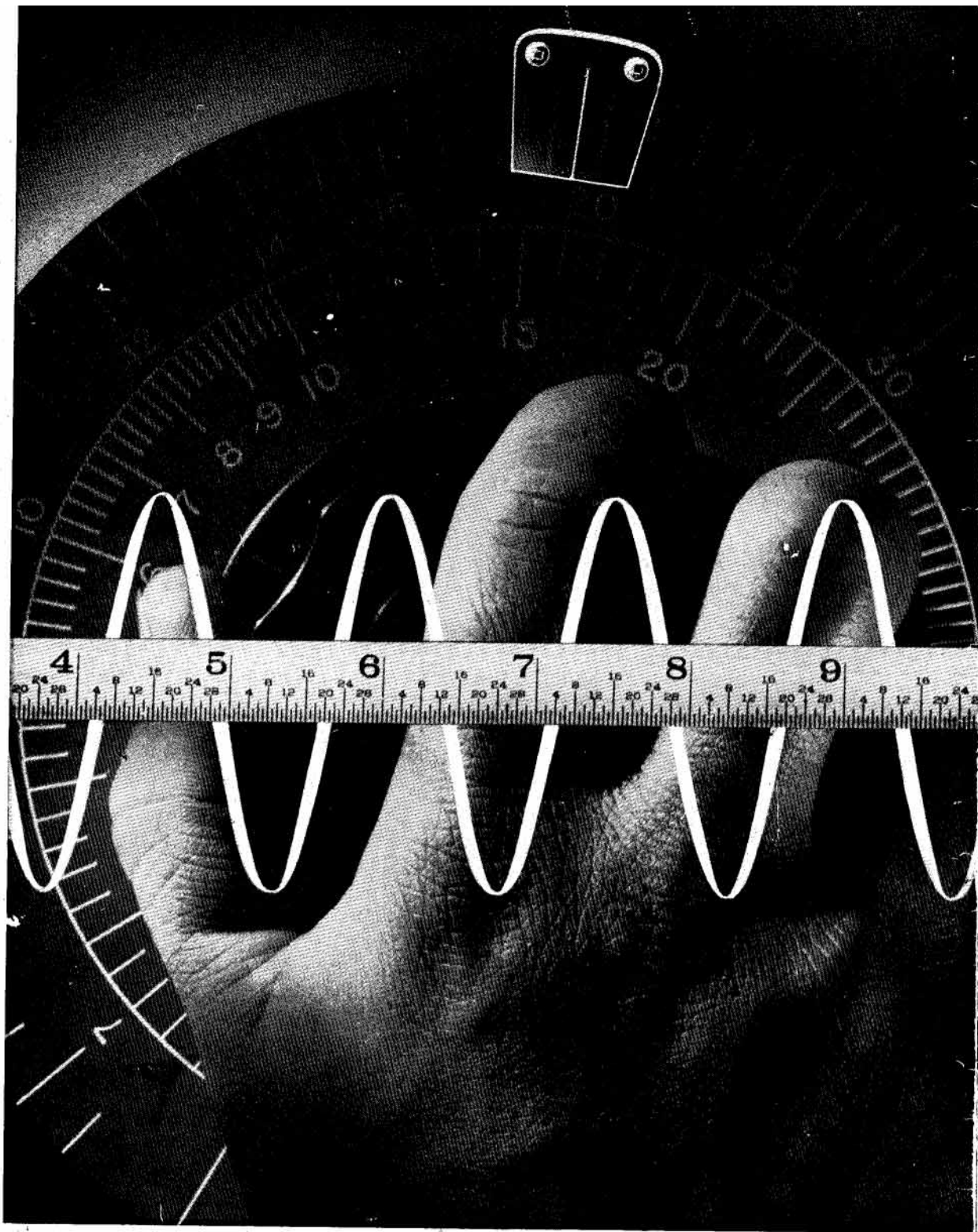

**CATALOG
19-A**

laboratory instruments
FOR SPEED AND ACCURACY

HEWLETT-PACKARD COMPANY
395 PAGE MILL ROAD • PALO ALTO, CALIFORNIA

INDEX



A complete, easy-to-use index of all *-hp-* instruments will be found inside this cover flap. This quick-reference index lists *-hp-* instruments by function and model number, and gives brief data on frequency range and other characteristics.

CATALOG



19-A

HEWLETT-PACKARD COMPANY

395 PAGE MILL ROAD • PALO ALTO, CALIFORNIA

FUNCTION	MODEL	FREQUENCY	CHARACTERISTICS	PAGES	
HARDWARE	10		Binding Post	33	
	14		Flexible coupler, ceramic insulated; permits misalignment of 1/32" and/or 5°	33	
LOW FREQUENCY STANDARDS	100A	100 kc, 10 kc, 1 kc, 100 cps	Accuracy 3 cps per mc per degree Centigrade	30-31	
	100B	100 kc, 10 kc, 1 kc, 100 cps	Temperature controlled; accuracy 0.001%	30-31	
FREQUENCY DIVIDER	110	100 to 10 cps	Controlled by 100A or 100B. Multipliers also available up to 1 mc	30-31	
RESISTANCE-TUNED OSCILLATORS	200A	35 to 35,000 cps	Output 1 watt into 500 ohms; 1% distortion	4-5-6-7	
	200B	20 to 20,000 cps	Output 1 watt into 500 ohms; 1% distortion	4-5-6-7	
	200C	20 to 200,000 cps	Output 10 volts into 1,000 ohms; 1% distortion	4-5-6-7	
	200D	7 to 70,000 cps	Output 10 volts into 1,000 ohms; 1% distortion	4-5-6-7	
	200I	6 to 6,000 cps	Frequency setting closer than 1%; output 10 volts into 1,000 ohms; 1% distortion	4-5-6-7	
	201B	20 to 20,000 cps	Output 3 watts at 1% and 1 watt at 1/2% distortion into 600 ohms	8-9	
	202B	1/2 to 1,000 cps	For low frequency studies. Output 10 volts into 1,000 ohms; 1% distortion	10-11	
	202D	2 to 70,000 cps	Output 10 volts into 1,000 ohms; 1% distortion	4-5-6-7	
	AUDIO SIGNAL GENERATORS	205A	20 to 20,000 cps	Output 5 watts, 1% distortion into impedances of 50, 200, 600, 5,000 ohms. Output VTVM and 110 db attenuator, 1 db steps	12-13
		205AG	20 to 20,000 cps	Same as 205A, plus separate VTVM for complete gain measurements	12-13
205AH		1 to 100 kc	Output 5 watts, 3% distortion into 50, 200, 500, 5,000 ohm impedances. Output VTVM and 110 db attenuator, 1 db steps	12-13	
206A		20 to 20,000 cps	Output +15 dbm with less than 0.1% distortion into 50, 150, 600 ohm impedances. Output VTVM and 111 db attenuator in 0.1 db steps	14-15	
SQUARE WAVE GENERATOR	210A	20 to 10,000 cps	Output 50 volts peak to peak; 1,000 ohm internal impedance; 70 db attenuator, 5 db steps	10-11	
WAVE ANALYZER	300A	30 to 16,000 cps	Variable selectivity; measurement range 1 mv to 500 volts; 5% accuracy	24-25	

FUNCTION	MODEL	FREQUENCY	CHARACTERISTICS	PAGES
DISTORTION ANALYZERS	320A	400 cps and 5 kc	Measures total distortion as low as 0.1%. 70 db attenuator, 1 db steps for comparison	20-21
	320B	50, 100, 400 cps and 1, 5 and 7.5 kc	Same as 320A	20-21
	325B	30, 50, 100, 400, 1,000 cps; 5, 7.5, 10 and 15 kc	Measures total distortion as low as 0.1%. Input amplifier and complete VTVM each usable separately	22-23
	330B	Any frequency 20 to 20,000 cps	Similar to 325B but measures at any frequency and includes AM detector	22-23
	330C	Any frequency 20 to 20,000 cps	Similar to 330B, no AM detector. Meter has VU characteristics to meet FCC requirements for FM broadcasting	22-23
FM BROADCAST MONITOR	335B	88 to 108 mc	FCC approved. Monitors carrier frequency and modulation. High fidelity output for aural monitoring	38-39
ATTENUATORS	350A	Max 100 kc	110 db, 1 db steps; 5 watts, 500 ohm level. Bridged T type. Accuracy 1 db in 50 db at 100 kc	32-33
	350B	Max 100 kc	Same as 350A but 600 ohm level	32-33
VACUUM TUBE VOLTMETERS AND ACCESSORIES	400A	10 cps to 1 mc	Nine ranges 0.03 to 300 volts full scale. Accuracy $\pm 3\%$ to 100 kc, $\pm 5\%$ to 1 mc. Average reading. Calibrated in rms.	26-27
	410A	20 cps to 700 mc	AC: six ranges 1 to 300 volts. DC: seven ranges 1 to 1,000 volts. Resistance: seven ranges 0.2 ohm to 500 megohms	28-29
	455A	to 1,000 mc	Connects probe of 410A across 50 ohm transmission line. Type N fittings	40
	458A	to 1,000 mc	Connects probe of 410A to open end of 50 ohm transmission line. Type N fittings	40
	AMPLIFIERS	450A	10 to 1,000,000 cps	40 db and 20 db stabilized gain. Input impedance 1 megohm shunted by approximately 15 uuf.
ELECTRONIC FREQUENCY METER	500A	5 cps to 50 kc	Ten ranges, $\pm 2\%$ accuracy. Input 0.5 to 200 volts	36-37
ELECTRONIC TACHOMETER	505A	300 to 3,000,000 rpm	Ten ranges, $\pm 2\%$ accuracy	37
	505B	5 to 50,000 rps	Same as 505A except calibrated in rps	37
SIGNAL GENERATORS	610A	500 to 1,350 mc	Calibrated output 0.1 microvolt to 0.1 volt. Internal pulse modulation. Direct calibration	20-21
	616A	1,800 to 4,000 mc	Direct reading. Pulse modulation, CW and FM. Calibrated output 0.1 microvolt to 0.2 volts	18-19
	650A	10 cps to 10 mc	Direct reading. Six bands. Output 3 volts to 600 ohm load. VTVM and output attenuator	16-17
POWER SUPPLY	710A		Any dc voltage 180 to 360 for 0 to 75 ma load; approximately 1% regulation. Also 6.3 volts, 5 amps ac.	34-35

SPEED AND ACCURACY ARE INTEGRAL PARTS OF EVERY *-hp-* INSTRUMENT

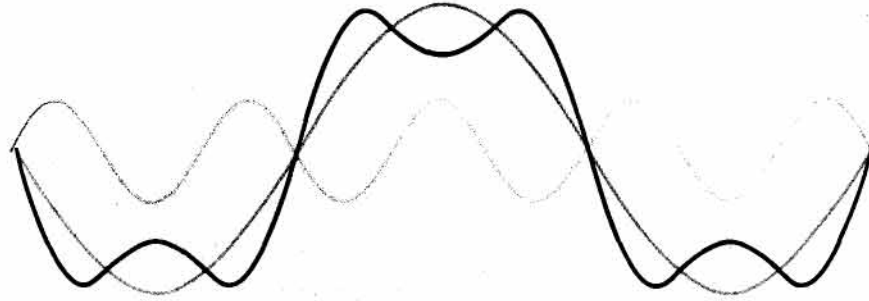

NEW ease and sureness in all types of laboratory and production testing are made possible by the use of *-hp-* instruments. Although each is tailored for very specific jobs, *-hp-* laboratory instruments have certain outstanding "family" characteristics. No zero setting, little or no adjustment during operation, virtual independence of line and tube characteristics, full protection against overloads, simple, accurate calibration, and streamlined circuits for clean and trouble-free performance are qualities you will find throughout the *-hp-* line.

-hp- instruments are essential and versatile tools in the fields of television, frequency modulation, radar, industrial heating, communications, carrier current, equipment manufacture, experimental work, broadcasting, industrial testing. Here is a partial list of the measurements that can be made with standard *-hp-* instruments: distortion, frequency, gain, voltage, network response, harmonic analysis, amplifier frequency response. They are also useful to establish standard frequencies, establish standard ratios by attenuation, and provide voltage for bridge measurements. Let *-hp-* instruments, products of sound engineering and precision manufacture, solve your testing and measuring problems.

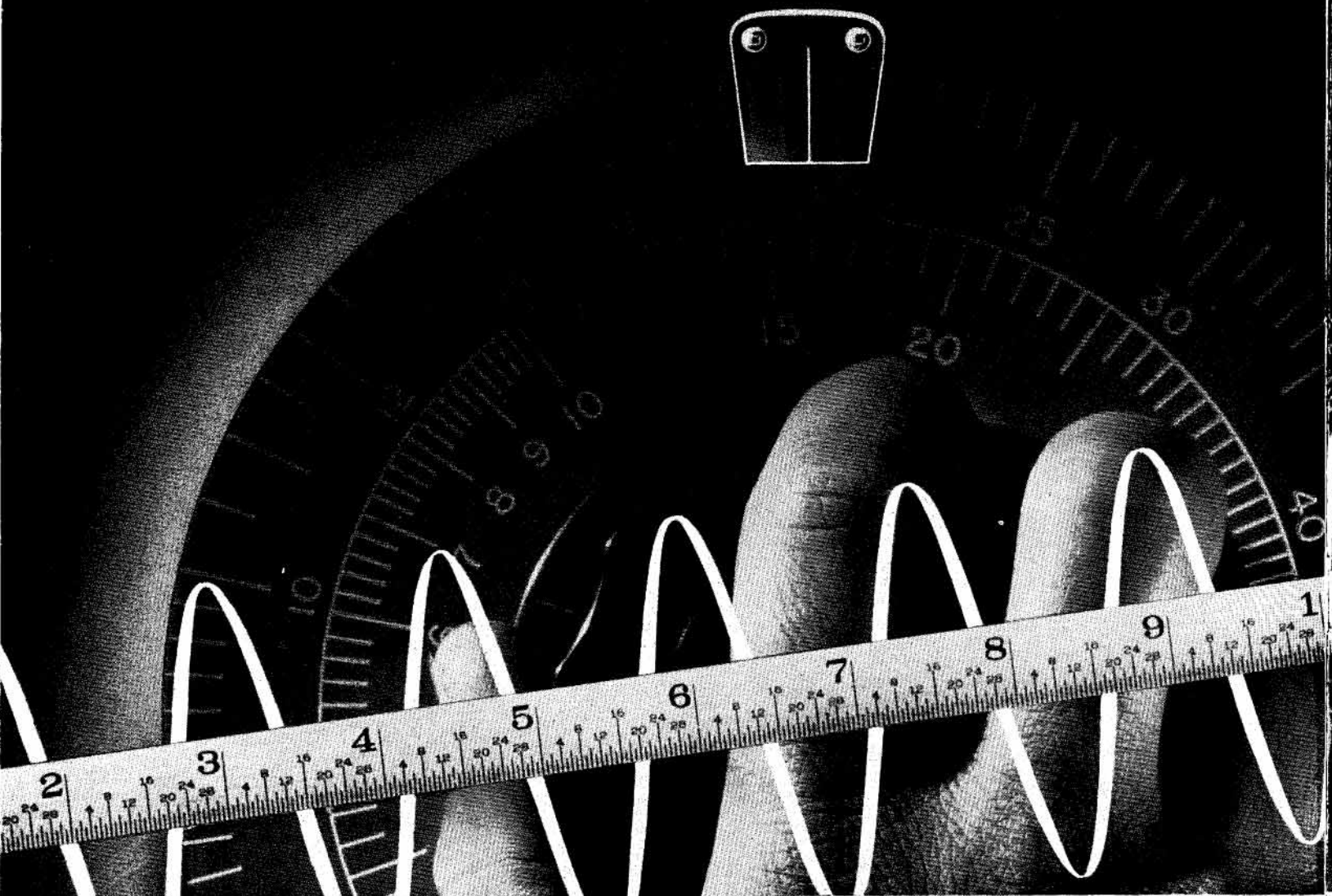

Lord Kelvin

HAD A WORD FOR IT



I often say that when you can measure what you are speaking about, and express it in numbers, you know something about it; but when you cannot measure it, when you cannot express it in numbers, your knowledge is of a meager and unsatisfactory kind; it may be the beginning of knowledge, but you have scarcely, in your thoughts, advanced to the stage of science, whatever the matter may be."

LORD KELVIN
1883

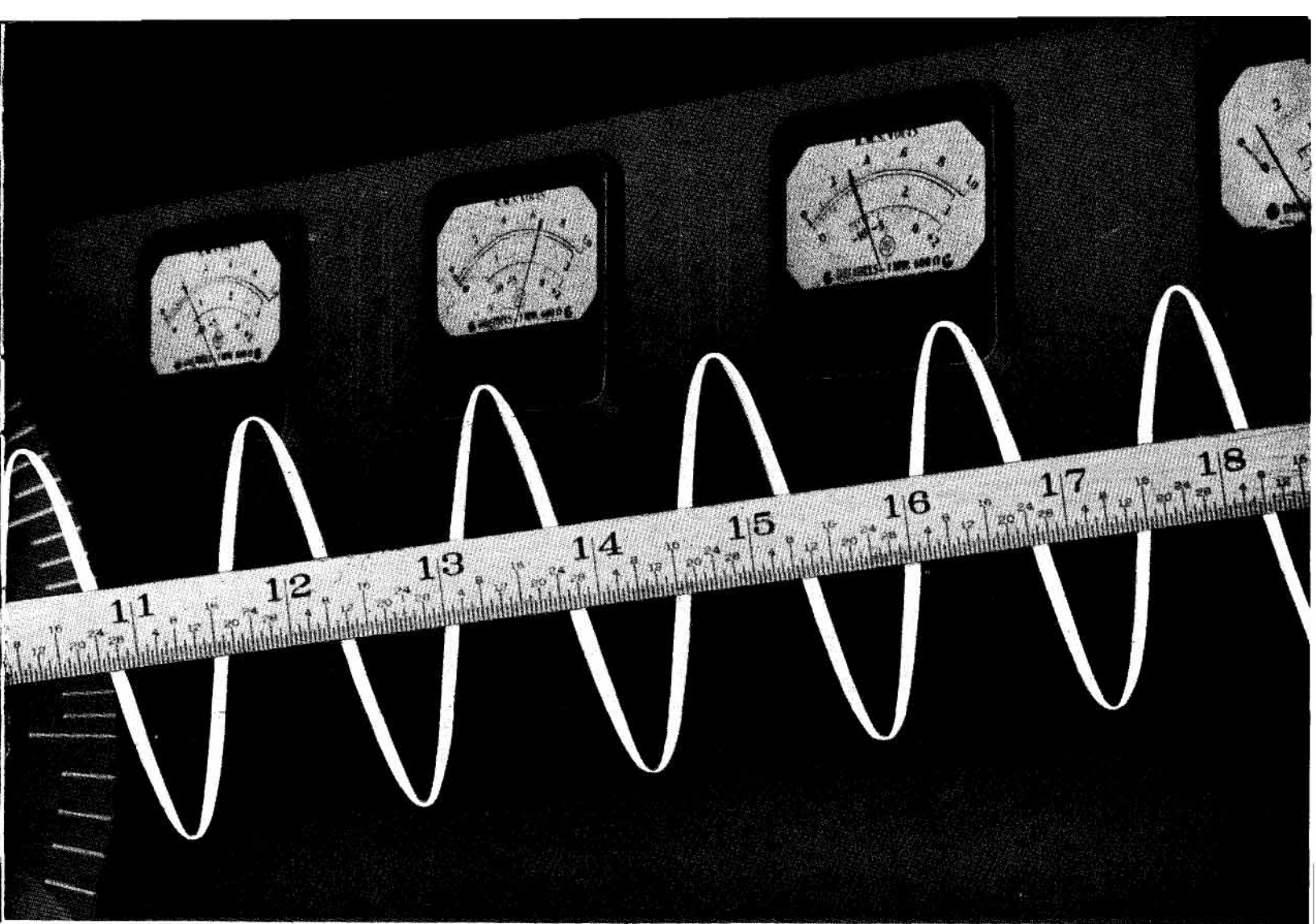

ENGINEERING TIME IS AN EXPENSIVE COMMODITY...

Probably in no other field is proper instrumentation so vitally important as in electronics. Lacking the proper instruments, it is not only difficult to design equipment correctly in the first place, but often impossible to tell whether it is behaving properly when completed.

To describe fully the performance of one of the simplest electronic devices—a single-stage amplifier—requires the measurement of operating voltages and currents, gain, frequency response, overload points, harmonic distortion, and noise level. In more complex apparatus the list would be greatly expanded. Many of these measurements must be made in high-impedance circuits where great care and judgment must

be exercised, not only in making the measurements themselves, but in interpreting the results.

Engineering time is a very expensive commodity. To employ it most efficiently, too much thought cannot be given to the selection of the proper tools. *-hp-* instruments are designed with convenience second only to accuracy in their requirements. By minimizing the time needed for routine measurements, and by guaranteeing the accuracy of the results, *-hp-* instruments render an outstanding service toward the advancement of the science of electronics. On the following pages you will find complete descriptions of a great many *-hp-* instruments. Please feel free to write us for any assistance or further information which you may require.



MODEL 200

AUDIO OSCILLATOR

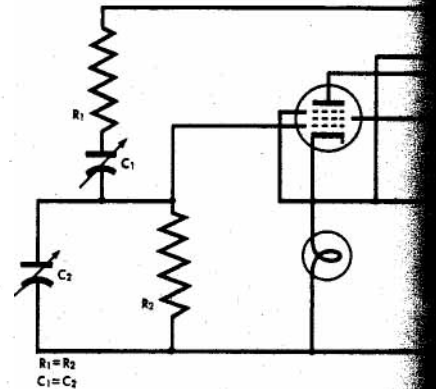
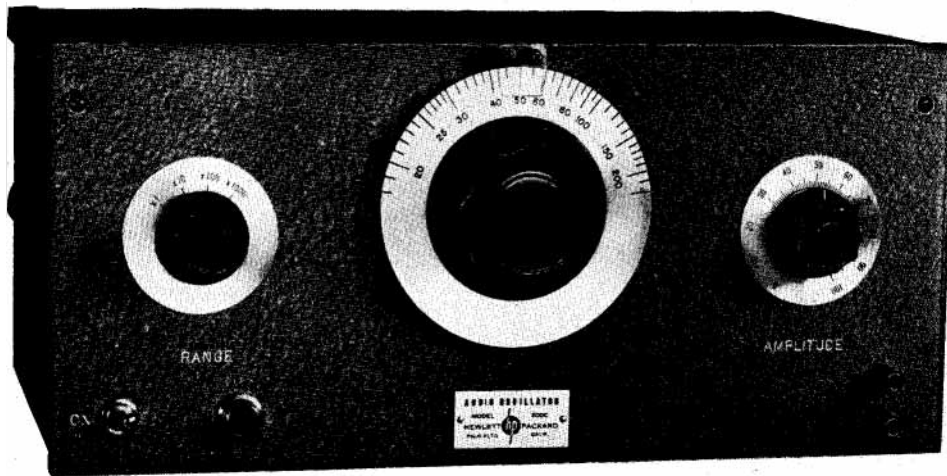

RESISTANCE-TUNED PRINCIPLE

HERE is a sound research story behind this revolutionary *-hp-* Resistance-tuned Audio Oscillator. Although audio-frequency oscillators have always been standard equipment throughout the communications and electronics fields, there were many "bugs" in types commonly available. These disadvantages included low stability, especially in the lower frequency ranges; need for constant resetting to insure accuracy; low portability, because of the essential weight and bulk of the instrument. So *-hp-* engineers set out to design and perfect an audio-frequency oscillator which would combine the high stability and very wide range of the coil-condenser type with the flexibility of operation of the beat frequency type. The result is the basically new Resistance-tuned Audio-frequency Oscillator, based on a new fundamental circuit and resulting in new speed and accuracy for electronic tests and measurements.

The fundamental resistance-tuned circuit of *-hp-* Audio Oscillators is shown above. The resonant frequency of this network is inversely proportional to the product of resistance and capacity. Thus the change in resonant frequency of this circuit is three times as great as that of the coil and condenser circuit. A ten to one frequency change is easily possible with the resistance-tuned circuit.

ADVANTAGES:

- No zero setting. Great stability
- Constant output
- Wide frequency range
- Logarithmic scale
- Low distortion. Light weight

USE THEM FOR:

- Amplifier testing
- Broadcast transmitter audio response
- Source of voltage for bridge measurements
- Modulating signal generators
- Supersonic voltage source
- Driving mechanical systems
- Synchronizing pulse generators
- Loud speaker resonance tests

The resistance-capacity (frequency determining) network is operated in conjunction with a stabilized amplifier. Positive feedback is applied to this amplifier through the resistance-tuned network, resulting in a very high effective Q for the circuit. See figure 1. Negative feedback is also used, and operates in conjunction with a non-linear resistor to limit amplitude and decrease distortion. It also helps in providing a constant and extremely stable output over the entire range. See figure 2.

NO ZERO SETTING

The excellent physical layout of *-bp-* Audio Oscillators has much to do with their satisfactory performance. Thermal drift is kept at a minimum by proper placement of components, and by means of low temperature coefficient elements in the resistance network. Furthermore, this thermal drift is not magnified, as is the case with the beat frequency type oscillator. Thus calibration is accurate under all operating conditions, without the inconvenience of constant zero setting, even within the first few minutes of operation. The constant output of these oscillators makes it easy to check the frequency response of the apparatus quickly, easily, accurately.

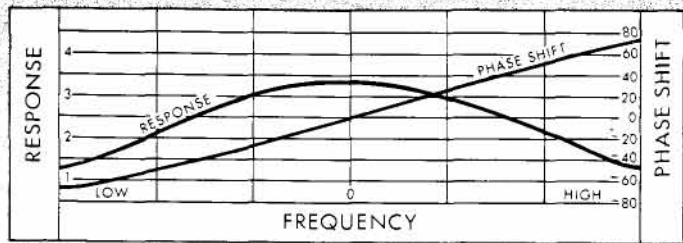

Figure 1

ONLY THREE DIALS

There are only three controls on the panel. They are the main frequency dial which covers a frequency range of 10 to 1; a range switch which selects the desired frequency band, and an amplitude control to vary the output signal level.

USES

The primary function of an audio-frequency oscillator is to generate an accurately controlled signal of known frequency. This signal may be used to check the performance of audio amplifiers, broadcast transmitters, and similar equipment. Although applications in the related fields of electronics are of first importance, the usefulness of the *-bp-* Resistance-tuned Audio Oscillator is by no means limited to the electrical engineering fields. They may be used, for example, to drive mechanical systems, in order to measure resonance and stability. Other measurements of mechanical equipment include measurements of the output frequency of rotating equipment, such as generators and dynamotors.

-bp- Resistance-tuned Audio Oscillators provide an excellent source of voltage for accurate bridge measurements. The output is sufficient to drive signal generators and other equipment requiring considerable power. Certain models are also adapted to work in the supersonic range.

The usefulness of these oscillators is greatly increased because they are small and light in weight; thus easy to carry around. In short, the speed and accuracy of *-bp-* Resistance-tuned Audio Oscillators make them ideal for an almost endless number of exacting jobs.

SPECIFICATIONS

Six standard models are available. The Models 200A and 200B have a transformer-coupled output amplifier which will deliver 1 watt into a matched load and are principally designed for use in audio testing. The Models 200C and 200D have a resistance-coupled output amplifier to provide uniform output voltage over their wide frequency range; they are principally useful when handling a wide range of frequencies, where a smaller amount of power is sufficient. Model 202D is a modification of Model 200D, with the frequency range extended down to 2 cycles per second. It is particularly useful where it is necessary to generate an extremely wide range and where low frequencies are involved, as in mechanical vibration problems. The Model 200I is an oscillator of the band spread type. It is intended for interpolation work and for applications where it is necessary that the frequency of oscillation be known very accurately. These oscillators are supplied in a relay rack mounting, as the 200AR, 200BR, 200CR, 200DR, 202DR, and 200IR.

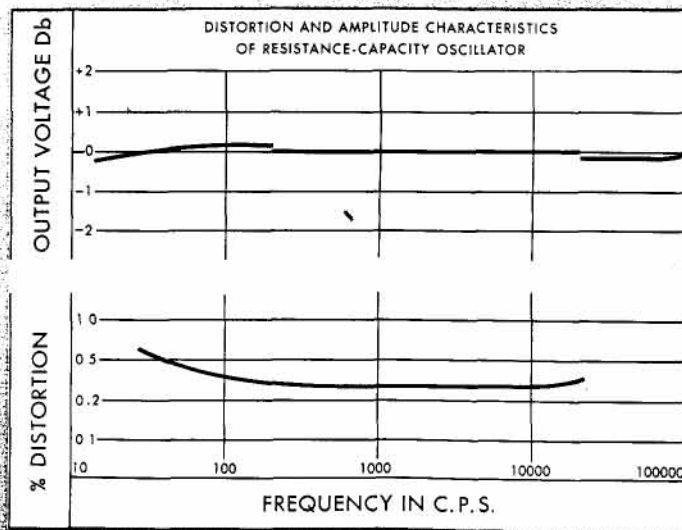
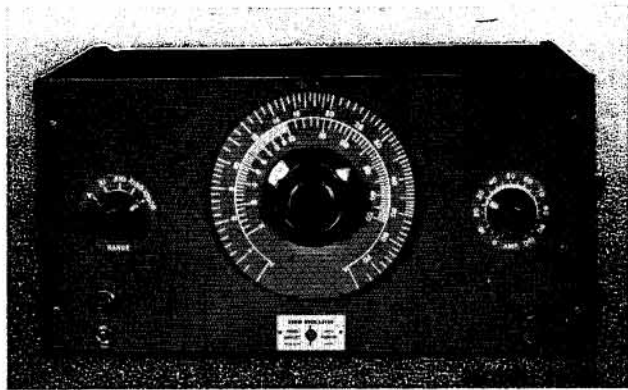

Figure 2



FREQUENCY RANGE

Model 200A	35 cps to 35 kc
Model 200B	20 cps to 20 kc
Model 200C	20 cps to 200 kc
Model 200D	7 cps to 70 kc
Model 202D	2 cps to 70 kc
Model 200I	6 cps to 6 kc

Calibration: The dial is calibrated directly in cycles for the lowest range. A switch selects the range and indicates the proper multiplying factor. The dial calibration of Models 200A, 200B, and 200C covers approximately 180 degrees, with an equivalent scale length of 20 to 30 inches. Models 200D and 202D have dial calibrations covering approximately 300 degrees with a scale length of about 60 inches. Model 200I is calibrated over approximately 300 degrees, and has a scale length of approximately 90 inches.

	200A	200B
Range 1	35 - 350 cps	20 - 200 cps
Range 2	350 - 3500 cps	200 - 2000 cps
Range 3	3500 cps - 35 kc	2000 cps - 20 kc

	200C	200D
Range 1	20 - 200 cps	7 - 70 cps
Range 2	200 - 2000 cps	70 - 700 cps
Range 3	2000 cps - 20 kc	700 - 7000 cps
Range 4	20 - 200 kc	7000 cps - 70 kc

Model 202D is similar to Model 200D, with the addition of a 2-50 cps band covering approximately 200 degrees on the main tuning dial.

200I			
Ax1	6 - 20 cps	Bx10	200 - 600 cps
Bx1	20 - 60 cps	Ax100	600 - 2000 cps
Ax10	60 - 200 cps	Bx100	2000 - 6000 cps

Stability: Under normal conditions the frequency drift is less than $\pm 2\%$ or 0.2 cps (whichever is greater) including initial warm-ups. Plus or minus 10 volt line voltage variations change the frequency less than $\pm 0.2\%$ at 1 kc. No zero setting is necessary on these oscillators. On Model 200I, if the ranges are standardized against a suitable frequency standard from time to time, accuracy better than 1% can be maintained.

Output: The Models 200A and 200B will supply one watt or 22.5 volts output into a matched resistance load of 500 ohms, and 25 volts on open circuit. Models 200C, 200D, 202D, and 200I will deliver 100 milliwatts or 10 volts into a 1000 ohm load. The internal impedance of the output amplifier is in the order of 50 ohms at 1000 cps.

Frequency Response: The output voltages of Models 200A and 200B are constant within plus or minus one decibel from 20 cps to 15 kc. The output voltage of the Model 200C is constant within plus or minus one decibel from 20 cps to 150 kc. The output voltages of the Models 200D and 202D are constant within plus or minus one decibel from 7 cps to 70 kc. The Model 202D will be within plus or minus 2 decibels from 2 cps to 7 cps. The frequency response of the 200I is plus or minus one decibel from 6 cps to 6,000 cps.

Distortion: The total rms distortion contained in the waveform of the various models is within the following limits: Models 200A and 200B, less than 1% distortion from 35 cps to 15 kc. Model 200C, less than 1% distortion from 20 cps to 100 kc. Model 200D, less than 1% distortion from 10 cps to 70 kc. Model 202D, less than 2% at rated output voltage from 10 cps to 70 kc. Model 200I, distortion less than 1% above 10 cps, and only slightly more than this at lower frequencies.

Hum Voltage: On all models, the hum voltage is less than 0.1% of maximum output voltages.

Power Supply: 115 volts, 50/60 cycles, 60 watts.

Mounting: The cabinet models are mounted in an attractive steel cabinet finished in wrinkle gray.

The relay rack mounting fits the standard 19" relay rack with $\frac{3}{4}$ " spacing. The dust cover mounts on the chassis and is removable from the rear.

Model	Mounting	Length	Height	Depth	Weight
200A	Cabinet	16"	7"	9"	32 lbs.
200B	Cabinet	16"	7"	9"	32 lbs.
200C	Cabinet	16"	7"	9"	30 lbs.
200D	Cabinet	17"	8 $\frac{3}{4}$ "	11"	32 lbs.
202D	Cabinet	17"	8 $\frac{3}{4}$ "	11"	32 lbs.
200I	Cabinet	17"	8 $\frac{1}{2}$ "	10 $\frac{3}{8}$ "	32 lbs.
200AR	Relay Rack	19"	7"	9"	35 lbs.
200BR	Relay Rack	19"	7"	9"	35 lbs.
200CR	Relay Rack	19"	7"	9"	35 lbs.
200DR	Relay Rack	19"	8 $\frac{3}{4}$ "	11"	37 lbs.
202DR	Relay Rack	19"	8 $\frac{3}{4}$ "	11"	37 lbs.
200IR	Relay Rack	19"	8 $\frac{3}{4}$ "	11"	37 lbs.

Average shipping weight 42 lbs.

Data subject to change without notice.

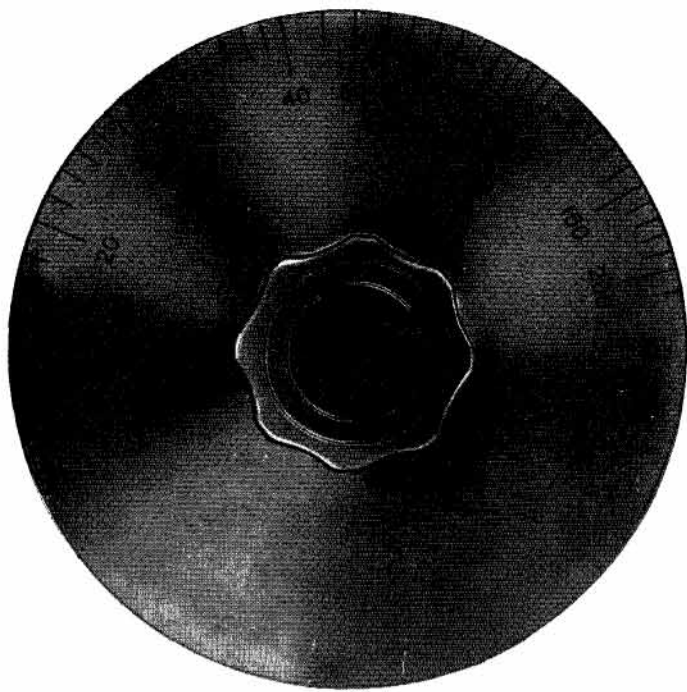

200B AND 200C

Here is the main tuning dial of *-hp-* Models 200B and 200C Audio Oscillators. Range is 20 cps to 20 kc on 200B, with dial calibrated over approximately 180° and effective scale length of about 20"; 200C has range of 20 cps to 200 kc and effective scale length of about 26".

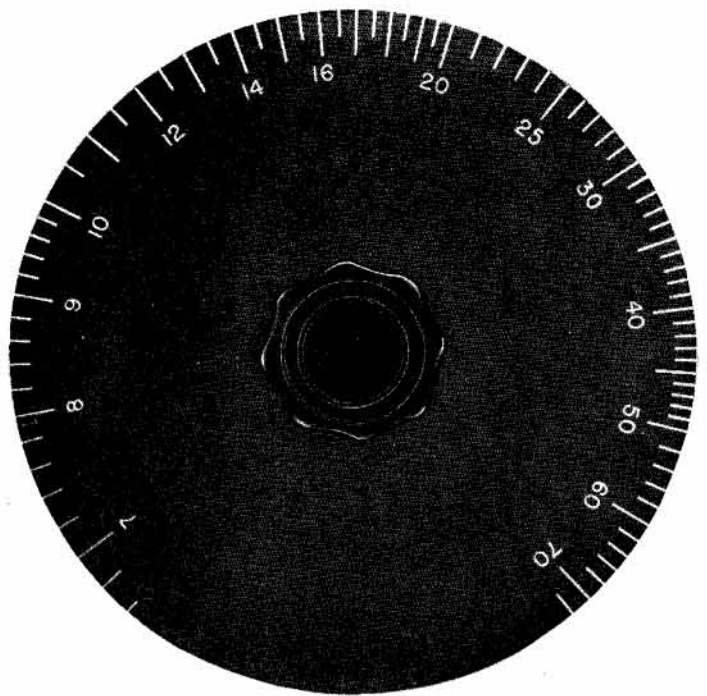

200D

Main tuning dial of *-hp-* Model 200D is calibrated over approximately 300° and has an effective scale length of about 60". This wide range instrument (from 7 cps to 70 kc) owes much of its speed and accuracy of operation to the precisely calibrated and easily controlled tuning dial pictured above.

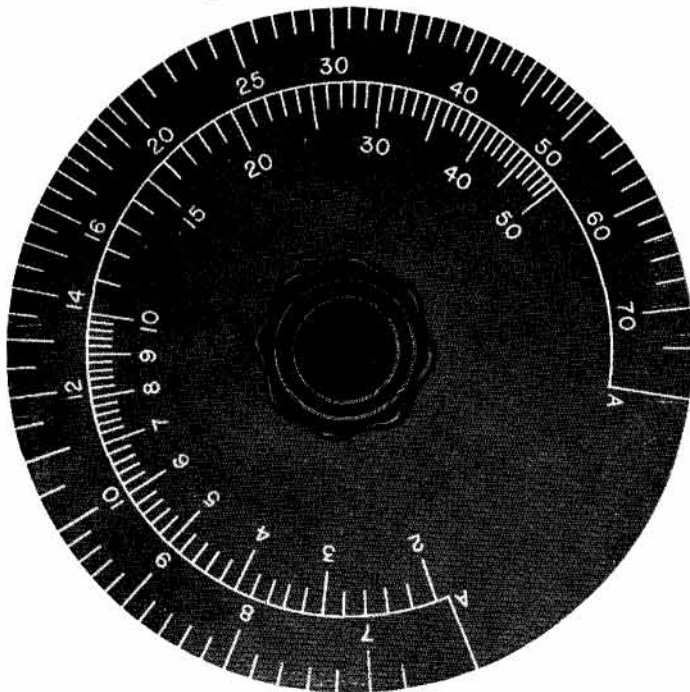

202D

The *-hp-* Model 202D is a modification of the 200D, which extends the range down to 2 cps. The tuning dial is calibrated over approximately 300°; the effective scale length is about 75". Before calibration, all *-hp-* Audio Oscillators are operated for a long period so as to be completely stabilized.

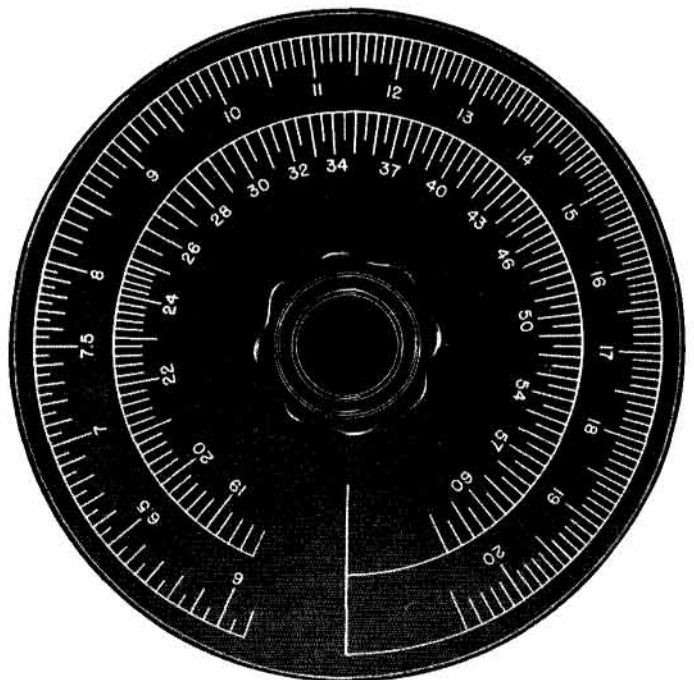

200I

Main tuning dial of the 200I, which is an oscillator of the band-spread type, intended for comparison work. The dial is calibrated over approximately 300° with effective scale length about 90" and range of 6 cps to 6 kc. Each Model 200I is carefully hand calibrated to insure maximum accuracy.



MODEL 201B

AUDIO OSCILLATOR

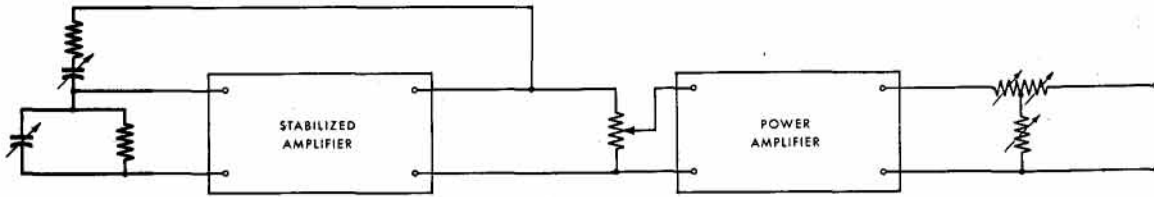

CHECK THE ADVANTAGES OF THIS FINE, NEW OSCILLATOR

ADVANTAGES:

- 3 watts output
- Distortion less than 1/2%
- Low hum level
- New dial with ball-bearing drive
- Accurate expanded frequency calibration
- Improved control of output level

USE IT FOR:

- High fidelity amplifier testing
- Transmission line measurement
- Loud speaker testing
- Frequency comparison

In FM and other fields where high fidelity is important, this new *hp*- Model 201B Audio Frequency Oscillator will meet every requirement for speed, ease of operation, accuracy and purity of wave form. The product of 6 years of *hp*- oscillator development, this new oscillator has many brand new features, in addition to the revolutionary resistance-tuned circuit which has made *hp*- a by-word in engineering circles.

The 201B has an accurate, convenient method of frequency control. The 6" dial, with smooth ball-bearing action, may be tuned by a directly controlled knob, or for still greater accuracy, may be set by the vernier which has a ratio of 6 to 1 to the main dial. The illuminated main dial is designed so that parallax is eliminated. It is calibrated over 300 degrees with approximately 95 calibration points and has an effective scale length of about 47 inches. Frequency range is 20 cps to 20 kc.

INCREASED POWER OUTPUT

The amplifier delivers up to 3 watts of power into a 600 ohm resistance load, with distortion held to 1%. Thus there is sufficient power available for driving almost any kind of laboratory or production equipment. Harmonic distortion may be kept to less than 1/2 of 1%, if the output of the amplifier is limited to 1 watt.

Another important feature of this oscillator is the provision which is made for standardizing each frequency range against a reliable standard, such as *hp*'s Model 100B Secondary Frequency Standard. By standardizing the instrument regularly, frequencies can be depended upon to be better than 1% accurate.

DUAL CONTROL FOR OUTPUT LEVEL

A new departure in oscillator design is the dual method for controlling output level. A volume control which is ahead of the amplifier controls the voltage at which the amplifier operates. An output attenuator is provided to attenuate the signal delivered by the amplifier. Attenuation is approximately linear from zero to 40 db. Both hum level and output voltage are thus attenuated together. As a result, hum level may be kept 60 db or more below the signal level, a special advantage in cases where small test signals are used.

The impedance looking back into the output circuit is about 50 ohms; thus the voltage regulation for varying loads is extremely good. For measurements where it is desirable to have impedance looking back into the instrument of 600 ohms, as in transmission measurements, the attenuator may be used to give about 10 db or more of attenuation, making the reflected impedance of the instrument about 600 ohms.

IMPORTANT DETAILS

Care has been taken to perfect every detail of this new oscillator. Improved chassis layout and placement of component parts minimizes thermal drift. The voltage on the oscillator is maintained constant with an electronic voltage regulator. The entire instrument is characterized by greater mechanical rigidity; the tuning assembly is mounted on a sturdy cast aluminum frame. The chassis itself is made of aluminum; the oscillator is light in weight and easy to handle.

SPECIFICATIONS, MODEL 201B AF OSCILLATOR

Frequency Range: The frequency range is from 20 cps to 20,000 cps covered in three bands.

Band	Frequency Coverage
x1	20 - 200 cps
x10	200 - 2,000 cps
x100	2,000 - 20,000 cps

Frequency Calibration: The calibration is direct in cycles per second for the lowest band. Approximately 95 calibration points are provided over a 300-degree arc. The dial is 6 inches in diameter, illuminated and driven by a vernier knob having 6:1 ratio. The effective scale length for the three bands is 47 inches.

Stability: Under normal temperature conditions the frequency stability is better than $\pm 2\%$, including the initial warm-up drift. Plus or minus 10 volt line voltage variations will result in no change in the output frequency. Adjustments are provided on each band to standardize the calibration against an accurately known frequency. With standardization the accuracy may be maintained better than $\pm 1\%$.

Output: The instrument is rated at a maximum of 3 watts or 42.5 volts into a 600 ohm resistive load. Maximum no load voltage is at least 50 volts. The impedance looking back into the output circuit (zero attenuator setting) is in the order of 75 ohms. With attenuator set at a value of 10 db or more the impedance looking back into the output is 600 ohms.

Frequency Response: The output voltage is constant within ± 1 db over the frequency range of 20 cps to 20,000 cps.

Distortion: The total rms distortion of the output wave over the range of 20 cps to 20,000 cps is less than the following limits:

3 watts output	1% distortion
1 watt output	.5% distortion*
*Down to 50 cps, at 20 cps 1% distortion.	

Volume Control: Two controls are provided for varying the output of the instrument:

1. An "Amplitude Control" adjusts the amount of oscillator voltage fed to the output amplifier.
2. An "Attenuator" attenuates the output of the amplifier. It is a variable T Pad having an attenuation range of 0 to infinity. Approximately linear in region 0 to 40 db.

Hum Voltage: The hum voltage is less 0.03% of maximum output voltage. If the output attenuator is used to control the output (with Amplitude control set for maximum rated power output) the hum level will be less than .1% below any signal level.

Power Supply: 115 volts ± 10 volts, 50/60 cycles. Power consumption: 75 watts. Plate supply voltage to oscillator section is electronically regulated.

Mounting: Cabinet Models are mounted in an aluminum cabinet finished in wrinkle gray. Size: 17 in. long x 8 1/2 in. high x 11 in. deep. Weight: 32 pounds. Shipping Weight: 46 pounds.

Data subject to change without notice.

hp MODEL 202B

LOW FREQUENCY OSCILLATOR

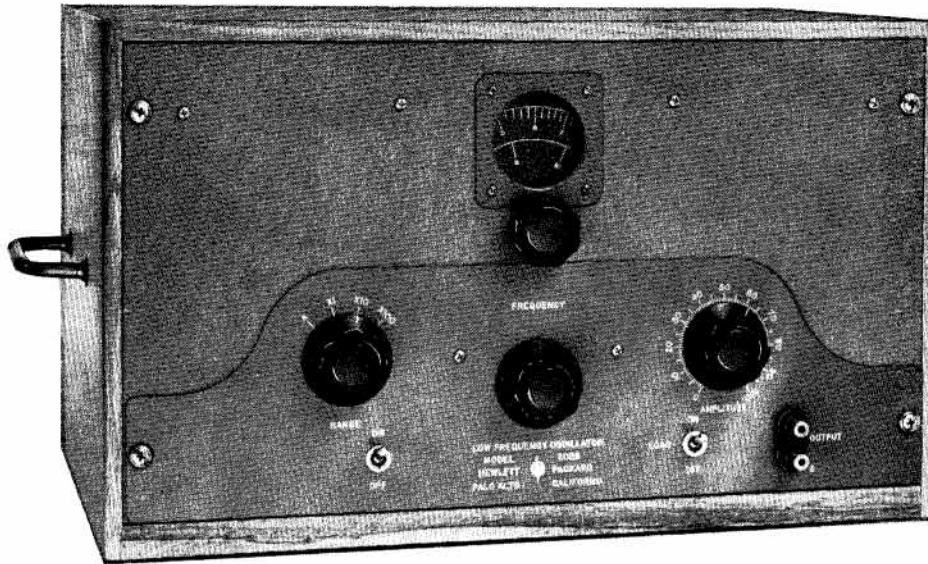

hp MODEL 210A

SQUARE WAVE GENERATOR



HIGH ACCURACY FOR LOW FREQUENCY MEASUREMENTS — 1/2 TO 1000 CPS

Now you can make low frequency measurements with all the precision and stability associated with audio frequency work. This *-hp-* 202B oscillator blankets the low-frequency spectrum from 1/2 to 1000 cps. Throughout this range it provides better wave form, higher stability and greater measuring accuracy than any instrument ever manufactured for industrial, field or laboratory use.

USES

The *-hp-* 202B gives maximum measuring speed and accuracy for these important tests: Vibration or stability characteristics of mechanical systems, electrical simulation of mechanical phenomena, electro-cardiograph and electro-encephalograph performance, seismograph response, vibration checks of structural components, performance of geophysical prospecting equipment.

SPECIFICATIONS

Frequency Range: 1/2 cps to 1000 cps in 4 ranges

Range	Frequency
A	1/2—1 cps
x1	1—10 cps
x10	10—100 cps
x100	100—1000 cps

SQUARE WAVES FOR RAPID TESTING 20 CPS TO 100 KC

The *-hp-* Model 210A Square Wave Generator provides an excellent source of square waves for production tests and experimental purposes. The fundamental frequency range is 20 cps to 10,000 cps. A reasonably square wave may be obtained at frequencies as high as 100 kc. The square wave frequency is synchronized from an external source of 2 or more volts. Output can be attenuated 70 db from a maximum voltage of 50 volts, peak to peak. Output voltages balanced to ground.

USES

The *-hp-* 210A is ideal for testing receivers, video amplifiers, networks and transmitters; to measure time constants or provide a time base, check cathode ray sweep circuits, generate harmonics for frequency multiplication or control an electronic switcher. It may also be used to indicate phase shift, frequency response, or transient effects.

SPECIFICATIONS

Frequency Range: 20 cps to 10,000 cps. Voltage rise time: Approximately 1 microsecond to 90% of maximum. Flat top of wave decays less than 1%.

Output Voltage: Approximately 50 volts, peak to peak, open circuit. The output impedance is 1,000 ohms, balanced to the ground.

Frequency Dial: 6" diameter. Reads directly in cps for two lower ranges. Dial is back of panel, illuminated, and is controlled by direct drive as well as a 6 to 1 vernier.

Accuracy of Calibrations: ±2%.

Frequency Stability: ±5% under normal temperature conditions (including warm-up drift). Less than ±1% for power voltage changes of ±10%.

Output: 10 volts into a 1000 ohm resistive load over the entire frequency range. Internal impedance approximately 25 ohms at 10 cps.

Frequency Response: ±1 db 10 to 1000 cps.
±2 db 1 to 1000 cps.

Distortion: Less than 1% total distortion, 1 to 1000 cps.

Hum Voltage: Less than 0.1% of rated output voltage.

Recovery Time: 30 to 60 seconds on lowest frequencies.

Power: 115 volts ±10 volts, 50/60 cps.

Size: 17" long, 12 3/4" deep, 10 1/2" high.

Mounting: Wrinkle gray panel, oak cabinet.

Net Weight: 50 pounds. Shipping Weight: 92 pounds.

Data subject to change without notice.

Output Attenuator: 70 db in 5 db steps.

Driving Voltage: 2 volts required. Input impedance 25,000 ohms. May be internally driven with a-c power supply voltage.

Mounting: Steel Cabinet: 15" long, 7" high, 9" deep. Relay Rack: 19" long, 7" high, 8" deep.

Power Supply: Built-in. Operates from 115 volt 50/60 cycle. Requires approximately 85 watts.

Net Weight: 30 pounds. Shipping Weight: 39 pounds.

Data subject to change without notice.

1. Square wave distortion from poor high frequency response.



2. Square wave distortion from poor response at both high and low frequencies.



3. Square wave test on feedback amplifier showing peak at 9 times square wave frequency.





MODEL 205 AG

AUDIO SIGNAL GENERATOR

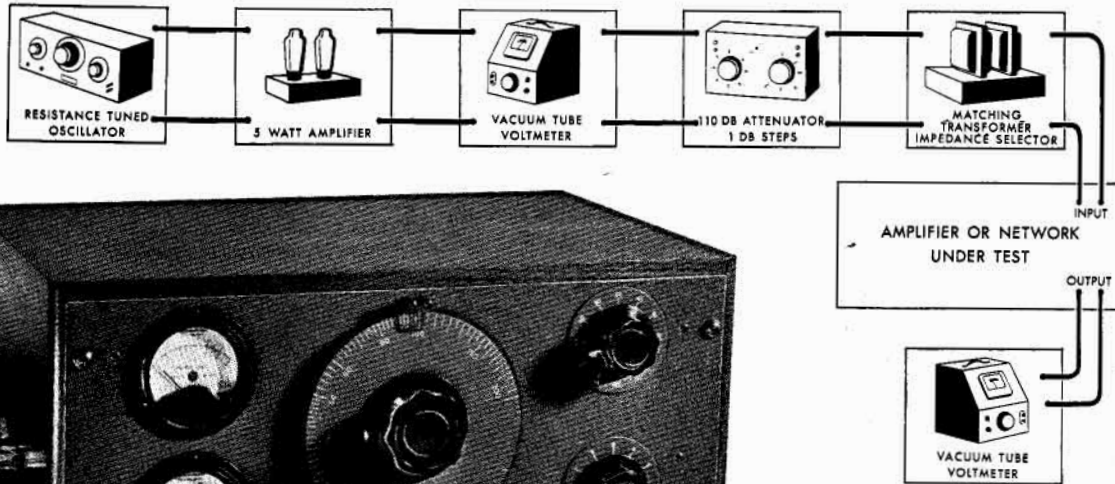

ADVANTAGES:

- No auxiliary equipment needed
- Range—20 to 20,000 cps
- 5 watts output, less than 1 % distortion
- No zero setting
- Supplies known voltage
- Output meter calibrated in volts and decibels
- Standardized frequencies instantly available
- Separate input meter for gain measurements
- Wide range of output impedances

USE IT FOR:

- Amplifier gain measurements
- Network frequency response
- Source of voltage for distortion measurements
- Broadcast transmitter audio response
- Loudspeaker response
- General laboratory applications
- Production testing

SIX BASIC INSTRUMENTS COMBINED TO SPEED GAIN MEASUREMENTS

ALL THE necessary instruments for accurate gain or frequency response measurements have been assembled by *hp*-engineers in one compact unit. (See block diagram.) No auxiliary equipment is required.

This Audio Signal Generator brings new speed and ease to testing jobs. Any desired frequency within the range of 20 to 20,000 cps is made available by the resistance-tuned audio oscillator. These frequencies are developed at any desired voltage between 150 volts and 50 micro-volts.

To make amplifier or network gain measurements with the *hp*-Model 205 AG Audio Signal Generator, the operator simply connects input and output leads to the binding posts.

Two vacuum tube voltmeters are provided, one to measure input and the second to measure output of the device under test. The input meter has a range of minus 5 db to plus 49 db, with an input impedance of 5,000 ohms. The attenuator sets the output voltage. The output impedance can be instantly changed by means of a selector switch (line matching transformer in the block diagram) to the commonly used impedances of 50, 200, 600, and 5,000 ohms, a convenience in

matching various types of networks. The Model 205AG will supply 5 watts output with less than 1% distortion, and thus is useful where sizeable amounts of power are required. Feedback is used for improved frequency response and lower distortion.

The *-hp-* Model 205AG is well adapted to measuring frequency response and gain or loss of any network. The frequency remains accurate, without the necessity of zero setting. *-hp-* Audio Signal Generators are built for heavy duty and long, hard service.

AUDIO AND SUPERSONIC MODELS AVAILABLE

There are three models of signal generators. The *-hp-* Model 205AG provides all of the basic components to make a complete gain measurement in one unit. The *-hp-* Model 205A is similar to the 205AG except that the input vacuum tube voltmeter is eliminated. For supersonic measurements the *-hp-* Model 205 AH Signal Generator is available. This instrument is similar to the *-hp-* Model 205A but covers a frequency range of 1 kc to 100 kc.

SPECIFICATIONS, MODELS 205AG AND 205A

Frequency Range: The frequency coverage is 20 cps to 20,000 cps, in three ranges.

Calibration: The dial is calibrated directly in cycles for the lowest range, 20 cps to 200 cps. A switch selects the desired range and indicates the proper multiplying factor. Each range covers approximately 270 degrees on the 6½" main dial. Range 1 covers 20 cps to 200 cps; Range 2 covers 200 cps to 2,000 cps; and Range 3 covers 2,000 cps to 20,000 cps.

Stability: Under normal temperature conditions the frequency will drift less than 2% over long periods of time. Each range is provided with an internal adjustment so that 1% accuracy may be maintained if required.

Output: Five watts output will be delivered to a matched resistance load.

Load Impedances: A switch selects transformer taps for use with loads of 50, 200, 600 and 5,000 ohm resistive loads. The output circuit is balanced and center tapped and any terminal may be grounded. The internal impedance is approximately 1/6 of the load impedance with zero attenuator setting. The internal impedance approaches the load impedance with attenuator settings of 20 db or more.

Frequency Response: The frequency response of the system beyond output meter is down 2.0 db at 20 cps and 1 db at 20,000 cps (at levels from +37 to -10 dbm). Drop in response exceeds these limits at levels lower than -10 dbm.

Distortion: The distortion is less than 1% at rated output at all frequencies above 30 cps.

Hum Level: The hum level is 60 db below the output voltage or 90 db below zero level, whichever is the larger.

Output Meter: The output meter is calibrated directly in volts at 600 ohms and in db above a 1 mw level (54.7 volts and plus 37 db full scale).

Input Meter:* The input meter has a range of minus 5 db to plus 48 db based on a 1 mw level in 600 ohms. The meter scale is calibrated from minus 5 db to plus 8 db and a multiplier switch adds from zero to 40 db to the reading in 5 db steps. The meter has an input impedance of 5,000 ohms.

*Not included in Model 205A.

Input Meter Response: The frequency response of the input meter is within ±0.2 db over range from 20-20,000 cps.

Output Attenuator: The output attenuator provides 110 db in 1 db steps. It consists of a 100 db attenuator with 10 db steps and a 10 db attenuator with 1 db steps.

Power Supply: 115 volts ±10 volts, 50/60 cycles. Power consumption: 125 watts.

Mounting: Available in either relay rack or cabinet mounting. Panel size on either instrument, 19" x 10½". Cabinet models are mounted in oak cabinets. Panels are finished in wrinkle gray enamel with machine engraved designations.

Net Weight: 73 pounds. Shipping Weight: 116 pounds.

MODEL 205AH SUPERSONIC SIGNAL GENERATOR

Frequency Range: 1 kc to 100 kc, in two ranges.

Power Output: 5 watts at 3% distortion, 3 watts at 1% distortion, 1 watt at ½% distortion.

Load Impedances: 50, 200, 500 and 5,000 ohm resistive. The output circuit is balanced and center tapped and any terminal may be grounded. The internal impedance is approximately 1/7 of the load impedance with zero attenuator setting. The internal impedance approaches the load impedance with attenuator settings of 20 db or more.

Frequency Response: ±1 db from 10 kc reference.

Hum Level: The hum level is at least 65 db below output voltage or 65 db below 1 milliwatt into 500 ohms, whichever is greater.

Output Attenuator: Range: 0 to 110 in 1 db steps. Accuracy: ½ db in first 80 db, 3 db in last 30 db.

Power Supply: 115 volts, 50-60 cycles, 125 watts.

Accuracy of Frequency: ±2%.

Stability of Frequency: ±½% after ½ hour warm up. Line voltage changes of ±10 volts have negligible effect on frequency as power supply to oscillator is regulated.

Output Meter: The output meter is calibrated directly in volts at 500 ohms and in db above 1 milliwatt level (50 volts and +37 db, full scale).

Mounting: Same as 205 AG.

Net Weight: 63 pounds. Shipping Weight: 110 pounds.

Data subject to change without notice.



MODEL 206A

AUDIO SIGNAL GENERATOR

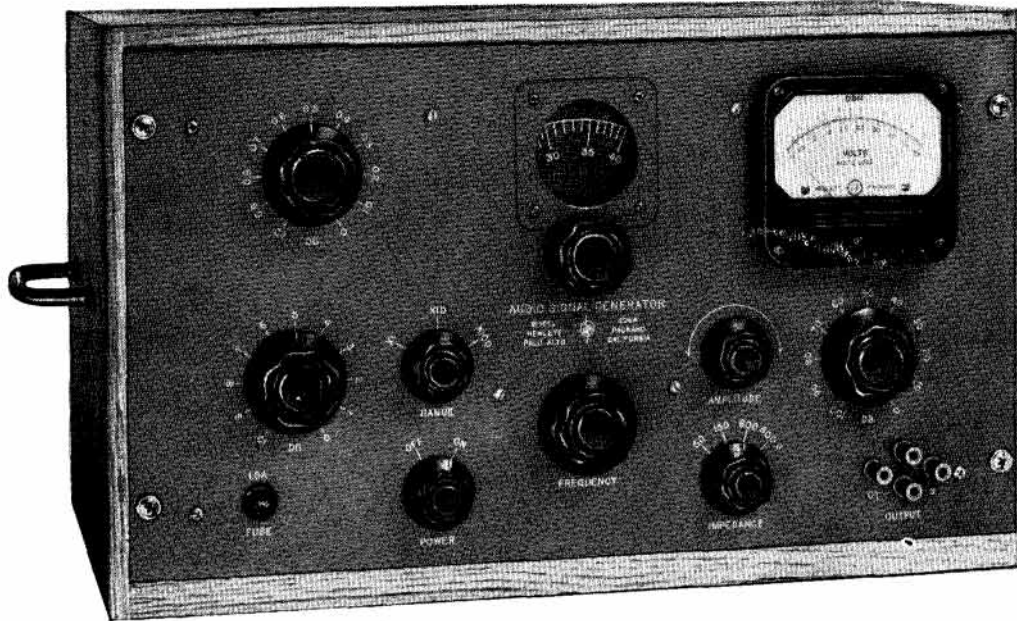

ADVANTAGES:

- Continuously variable a-f voltage
- Accuracy 0.2 db, any level
- High stability
- Harmonic distortion less than 0.1 %
- 111 db attenuator, 0.1 db steps

USE IT FOR:

- A-f voltage source
- Checking FM transmitter response and distortion
- Checking broadcast studio performance
- High-quality amplifier testing
- Transmission measurements

CONTINUOUSLY VARIABLE AUDIO SIGNALS LESS THAN 0.1% DISTORTION

THE newly-developed *hp*- Model 206A Audio Signal Generator provides a source of continuously variable audio frequency voltage at a total distortion level of less than 0.1%. This unique feature, coupled with simple, straight-forward circuitry, rugged construction and typical *hp*- ease of operation, makes this new signal generator ideal for use in the maintenance of FM broadcasting units and high fidelity audio systems.

CIRCUIT DESCRIPTION

The circuit arrangement of the Model 206A is shown in the block diagram, Figure 1. The oscillator section is followed by a tuned amplifier, automatically tracked with the oscillator. High selectivity of the amplifier reduces the harmonic voltages generated by the oscillator section. This serves to reduce the percentage of harmonic distortion in the voltage reaching the instrument's output terminals.

The selective amplifier is followed by an output amplifier, a vacuum tube voltmeter, an attenuator and finally an output matching transformer. An electronic voltage regulator supplies plate voltage for the complete circuit.

FREQUENCY DETERMINING NETWORK

The frequency determining network in the instrument's oscillator section is composed of low temperature coefficient elements, so that the instrument will have good stability over long periods of time. The frequency calibration of the instrument is accurate within 1%. Frequencies from 20 cps to 20 kc are continuously available. Three decade frequency ranges provide an effective scale length of 47". Tuning dial is controlled directly or with a 6 to 1 vernier micro drive for hair-line adjustments. Dial is read through a no-parallax illuminated window.

The output of the amplifier is measured by a vacuum tube voltmeter. Indications can be read in either volts or dbm to an accuracy of 0.2 dbm. Following the vacuum tube voltmeter is a 111 db attenuator which allows the power output to be varied in 0.1 db steps.

OUTPUT SYSTEM

The new -hp- 206A generator includes an output matching transformer which allows it to be matched to resistive loads of 50, 150 and 600 ohms. This output system is balanced to ground and each winding is center-tapped. The internal impedance matches the load impedance.

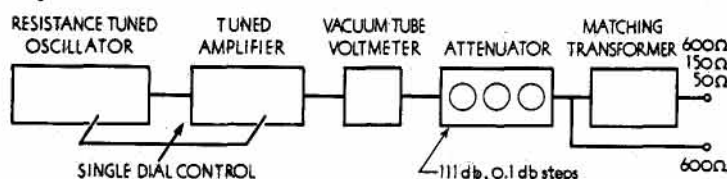

A single ended 600 ohm output is provided which bypasses the line-matching transformer. This output connection results in superior distortion and frequency response characteristics.

USES

This instrument is specifically designed for testing high quality audio circuits. It is suitable for FM transmitter maintenance, studio amplifier and console testing, a low distortion source for bridge measurements, for use as a transmission measuring set, and for any application requiring a low-distortion, accurately-known audio test signal.

SPECIFICATIONS

Frequency Range: The frequency coverage is from 20 cps to 20 kc in 3 ranges.

Calibration: The dial is calibrated directly in cycles for the lowest range, from 20 to 200 cps. Each range covers approximately 270 degrees of the 6" dial. The dial is located behind the panel and is illuminated. A six to one rim drive enables the equipment to be easily and quickly set to any desired frequency.

Stability: The frequency is calibrated to within better than 1% when the instrument leaves the factory. The circuit elements in the frequency determining network have low temperature coefficients and good stability so that excellent accuracy will be maintained over long periods of time.

Output: The equipment will deliver an output level of +15 dbm above 1 mw into impedance of 50, 150 and 600 ohms. Approximately 10 volts are available into an open circuit.

Output Impedances: The generator has a matched internal impedance and the selection of output impedances includes 50, 150 and 600 ohms center-tapped and balanced and 600 ohms single ended.

Frequency Response: The frequency response of the system beyond the output meter is better than 0.2 db at all levels, 30 cps to 15 kc.

Distortion: The total harmonic distortion in the output voltage is less than 0.1% at frequencies above 50 cps and less than 0.25% from 20 cps to 50 cps.

Hum Level: The residual hum and noise in the output signal is at least 70 db below the output signal or more than 100 db below zero level, whichever is the larger.

Output Meter: The output voltage is measured ahead of the attenuators by a 4" square meter calibrated in dbm and also in volts. The meter has a scale which can be read to at least 0.2 db at all points above a 50% scale reading. (Zero dbm equals 1 mw in 600 ohms.)

Output Attenuators: Output attenuators provide a range of 111 db in 0.1 db steps. The individual resistors in the attenuators are adjusted to better than 0.2% and the accuracy of the attenuators is approximately 0.1 db.

Mounting: The Model 206A is mounted on a standard relay rack size panel 10 1/2" by 19". The depth behind the panel is approximately 13". Either cabinet or relay rack mounting can be supplied. The panel is finished in smooth gray enamel, or special colors to match transmitter installations.

Power Supply: 115 volts, 50/60 cycles.

Net Weight: 65 pounds. **Shipping Weight:** 110 pounds.

Data subject to change without notice.



MODEL 650A

TEST OSCILLATOR



FAST, ACCURATE TESTS 10 CPS TO 10 MC

ADVANTAGES:

- No zero set
- Wide frequency range
- No adjustments during operation
- Output voltage attenuator
- Self-contained vacuum tube voltmeter
- High stability
- Ease of operation

USE IT FOR:

- Testing television amplifiers
- Wide-band systems
- Filter transmission characteristics
- Tuned circuit response
- Determining receiver alignment
- Telephone carrier measurements
- Bridge measurements

His *-hp-* Model 650A Oscillator is the newest and finest of the famous *-hp-* resistance-tuned oscillators. It is the first *-hp-* instrument of its kind to bring audio frequency speed, accuracy and ease of operation to higher frequency fields. Its unique frequency range, 10 cps to 10 mc, makes it ideal for a wide variety of measurements in audio, supersonic, video and r-f bands. It is a wide-band, highly-stable precision instrument which provides output flat within 1 db throughout its frequency range. Its voltage range is .00003 volts to 3 volts. Output impedance is 600 ohms. And, for measurements where low source impedance is desired, a 6 ohm impedance is provided by means of an output voltage divider.

DECADE RANGES, OUTPUT VOLTMETER

Like other *-hp-* resistance tuned oscillators, the new Model 650A is fast and easy to operate. Six decade frequency ranges provide an effective scale length of 94 inches. The tuning dial is controlled directly, or with a 6 to 1 vernier micro-drive

for hair-line adjustment. Frequencies are read through a no-parallax illuminated window.

The output voltage is monitored by a vacuum tube voltmeter which measures the voltage at the input to the attenuator system. The VTVM is calibrated in volts and decibels and reads actual output voltage when the attenuators are set for zero attenuation. For other attenuator settings true output voltage is obtained by subtracting the attenuator reading from the output voltmeter reading. The output attenuator is adjustable in 10 db steps and maximum attenuation is 50 db. The voltage applied to the vacuum tube voltmeter and thus to the output attenuator is set by means of an amplitude control. The attenuated output voltage is correct only when the output terminals are loaded with 600 ohms, resistive.

OUTPUT VOLTAGE DIVIDER

Where small test signals or a low source impedance is required, a voltage divider is provided (shown connected to instrument on page 16). The divider consists of a cable and terminating connector which may be extended to the actual point of measurement. Two sets of voltages are obtainable from this divider. One voltage is one one-hundredth of the normal output voltage from the 650A and is delivered from a source impedance of only 6 ohms. True voltage is obtained at these terminals when they are connected to a load resistance large compared to 6 ohms. The second voltage is the actual output voltage of the Model 650A and is delivered from a source impedance of 300 ohms. Proper voltage is obtained at these terminals when working into a load resistance large compared to 300 ohms.

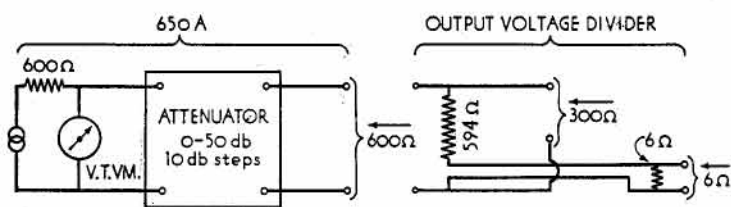

Figure 1

Circuits of the *-hp-* Model 650A have been carefully proportioned and low temperature coefficient components have been employed to assure highest frequency stability. Output voltage will remain constant over long periods of time, despite wide variations in temperature. Distortion over the low frequency bands is kept at a minimum to increase the usefulness of the instrument for audio measurements.

USES

Employing essentially the same resistance-tuned circuit as *-hp-* audio oscillators (see page 4 for description of the *-hp-* resistance-tuned principle) this wide-band, stable *-hp-* Model 650A is ideally suited for laboratory and production jobs where fast, accurate wide band measurements are required. It is specifically designed for the testing of television amplifiers, audio amplifiers, filter networks, tuned circuits and telephonic and telegraphic carrier equipment. It serves admirably as a power supply for a-f and r-f bridge measurements.

SPECIFICATIONS

Frequency Range: 10 cps. to 10 mc. Six bands.

Frequency Calibration: 1 to 10.

MF	Frequency Range
x10 cps	10 to 100 cps
x100 cps	100 to 1000 cps
x1 kc	1000 to 10,000 cps
x10 kc	10 to 100 kc
x100 kc	100 to 1000 kc
x1 mc	1 to 10 mc

Stability: $\pm 2\%$, 10 cps to 100 kc; $\pm 3\%$, 100 kc to 10 mc including warmup, line voltage, and tube changes.

Output: 15 milliwatts or 3 volts into 600 ohm resistive load. Open circuit voltage is at least 6 volts. 600 ohm source impedance. Source impedance of 6 ohms is available when voltage divider is used.

Frequency Response: Flat within ± 1 db, 10 cps to 10 mc into 600 ohm resistive load.

Distortion: Less than 1% from 100 cps to 100 kc. Approximately 5% from 100 kc to 10 mc.

Output Monitor: Vacuum tube voltmeter monitors level at input to attenuator, in volts or db at 600 ohm level. Zero db = 1 mw in 600 ohms. Accuracy $\pm 5\%$ of full scale reading.

Output Attenuator: Output level attenuated 50 db in 10 db steps, providing continuously variable output voltage from +12 dbm to -50 dbm, 3 volts to 3 millivolts, or down to 30 microvolts with voltage divider. Accuracy ± 1 db, into resistive load of 600 ohms.

Hum Voltage: Less than 0.5% of maximum attenuated signal level.

Power Supply: 115 volts 50/60 cps. Consumption 165 watts. Plate supply and h-f oscillator tube filaments electronically regulated.

Mounting: Cabinet or relay rack. Panel size 19" x 10 $\frac{1}{2}$ ". Depth 13". Wrinkle gray finish.

Net Weight: 46 pounds. Shipping Weight: 100 pounds.

Data subject to change without notice.



MODEL 616A

UHF SIGNAL GENERATOR

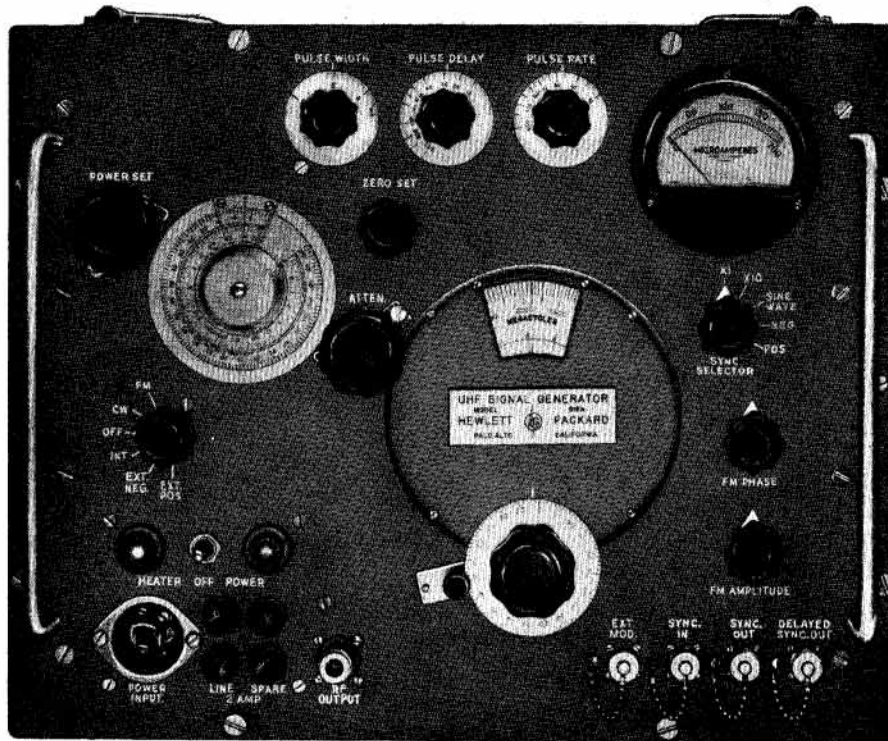

ADVANTAGES:

- Direct frequency control
- Direct voltage readings
- C-w, f-m, or pulsed output
- Variable pulse rate
- Synchronized pulsing
- Wide frequency range
- Great stability
- Rugged, compact

USE IT TO MEASURE:

- Receiver sensitivity
- Signal-noise ratio
- Conversion gain
- Standing wave ratios
- Antenna gain
- Transmission line characteristics

FAST DIRECT READINGS 1800 TO 4000 MC

At the time of operation, direct reading without reference to calibration charts, one-dial frequency control, great stability, and precision accuracy between 1800 and 4000 mc—those are but a few of the advantages of this new *-hp-* Model 616A Signal Generator.

Operation of the new *-hp-* 616A is extremely simple. For example, carrier frequency in mc may be directly set and read on the large tuning dial. No voltage adjustments are necessary during operation, because the unique, *-hp-* developed coupling device causes oscillator repeller voltage to automatically track frequency changes. R-f output from the reflex klystron oscillator is directly set and read on a simplified output dial. It may be continuous or pulsed, or frequency modulated at power supply frequency. Pulse modulation may be provided externally or supplied internally. Internal pulsing may be synchronized with either positive or negative external pulses, or sine waves. R-f pulse may be delayed 3 to 300 microseconds with respect to external synchronizing pulse.

The oscillator portion of the new *-hp-* 616A Signal Generator is of the reflex klystron type, with an external resonant cavity. Frequency of oscillation is determined by a movable plunger which varies the parameter of the cavity. Oscillator output is monitored by a temperature-compensated thermistor bridge circuit which operates virtually unaffected by ambient temperature conditions. Voltage beyond the monitored output level is passed through a piston attenuator which is so designed that attenuation is linear over a range of 120 db or more. Voltage output is directly read on the scale.

Because of its wide range and great stability, the *-hp-* 616A UHF Generator is ideal for almost any precision uhf application. It is easy to use, compact to save bench space, and ruggedly-built of finest components for long, trouble-free service.

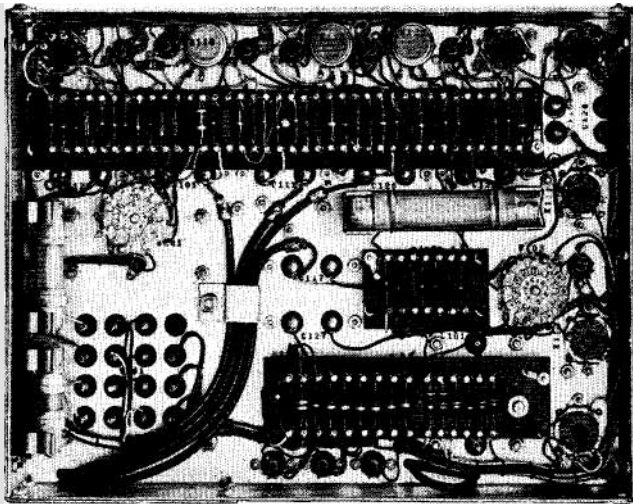

Fig. 1 — Rear view of *-hp-* 616A UHF Signal Generator, showing compact arrangement and ready accessibility of all components.

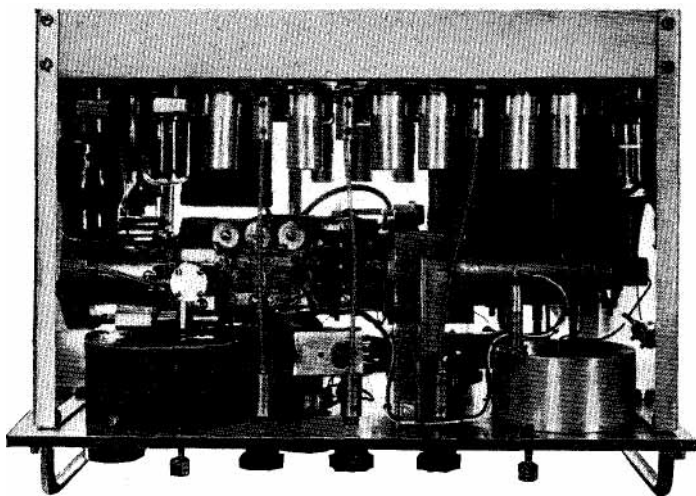

Fig. 2 — Top view of signal generator showing klystron oscillator cavity and bolometer circuits. Aperture at right permits easy replacement of oscillator tube.

S P E C I F I C A T I O N S

Frequency Range: 1800 to 4000 megacycles.

Selection is made by means of a single directly-calibrated control covering the entire range. No charts are necessary.

Frequency Calibration Accuracy: $\pm 1\%$.

Frequency Stability: 0.005% per degree centigrade change in ambient temperature; line voltage changes of ± 10 volts cause less than 0.01% frequency change.

Output Range: 1 milliwatt or .223 volts to 0.1 microvolt (0 dbm to -127 dbm). Directly calibrated in microvolts and db; continuously monitored.

Attenuator Accuracy: Within ± 1 db without correction charts. A correction chart is provided when greater accuracy is desired.

Output Impedance: 50 ohms, nominal.

Modulation: Internal or external pulse or f-m.

Internal Pulse Modulation: Repetition rate variable from 40 to 4000 per second; pulse length variable from 1 to 10 microseconds; and delay variable from 3 to 300 microseconds (between synchronizing signal and r-f pulse).

Trigger Pulses Out:

1. Simultaneous with r-f pulse.
2. In advance of r-f pulse, variable 3 to 300 microseconds. (Both approximately 0.5 microsecond rise time, height 25-50 volts.)

External Sync Pulse Required: Amplitude from 10 to 50 volts of either positive or negative polarity and 1 to 20 microseconds width. May also be synchronized with sine waves.

FM Modulation: Oscillator frequency sweeps at power line frequency. Phasing and sweep range controls provided. Maximum deviation approximately ± 5 mc.

Power Source: The instrument operates from a 105-125 volt 50/60 cycle, single phase source.

Approximate Size: 17" long, 13 $\frac{1}{4}$ " high and 13 $\frac{1}{2}$ " deep.

Data subject to change without notice.

hp MODEL 610A

UHF SIGNAL GENERATOR

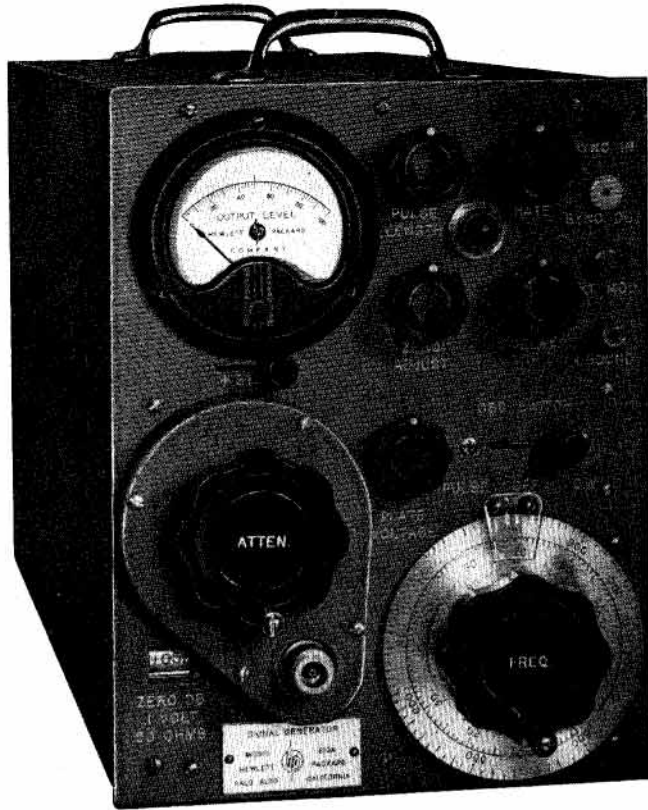

hp MODEL 320

DISTORTION ANALYZER

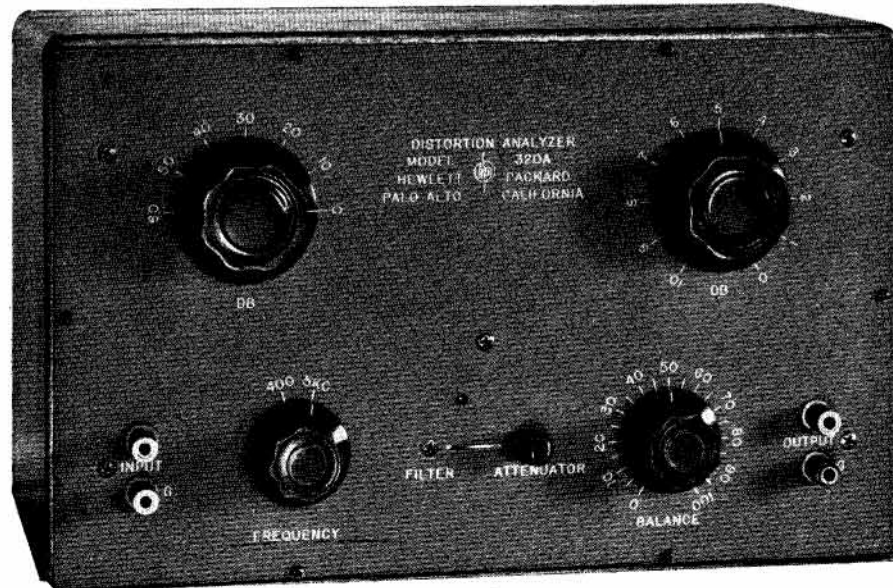

GENERAL PURPOSE UHF SIGNAL GENERATOR, 500 TO 1350 MC

The *-hp-* Model 610A Signal Generator provides a general purpose laboratory standard for measurements between 500 and 1350 mc. It supplies an accurately known voltage throughout this range, from 0.1 microvolt to 0.1 volt. Output voltage and frequency are directly selected and read without reference to calibration charts.

The *-hp-* 610A includes a high-frequency oscillator, and an attenuator for accurately controlling output beyond a measured level. Also included is an internal pulser and modulator, and a regulated power supply to provide oscillator plate voltage. The oscillator employed is of the concentric type, utilizing a "lighthouse" tube, and is adjusted by the positioning of the shorting plungers in the concentric lines. Output voltage is derived through a mutual inductance type attenuator, coupled to the oscillator cavity. R-f voltage at attenuator input is measured by a thermistor bolometer.

Internal pulsing circuits provide rectangular, r-f, pulsed output of variable lengths and repetition rates. The pulse rate may be synchronized from an outside source. An external synchronizing pulse is provided. R-f signal may also be externally amplitude modulated.

SPECIFICATIONS

Frequency Range: 500-1350 mc directly calibrated.

Attenuator: Mutual inductance piston type, directly calibrated in db below 0.1 volts in 50 ohms; 120 db maximum attenuation.

Output: Accurately known voltages from 0.1 microvolt to 0.1 volt supplied through 50-ohm coaxial cable terminated in type "N" connector. Internal impedance 50 ohms. Accuracy better than ± 1 db over entire range. Calibration charts supplied where greater accuracy required.

Modulation: Internal pulse, external pulse, external square wave, external amplitude.

Internal Pulser: Pulse length variable 2 to 50 microseconds. Repetition rate variable 60 to 3000 cps. Pulse delay variable 3 to 300 microseconds (between externally supplied synchronizing pulse and beginning of r-f pulse).

Leakage: Sufficiently low to permit measurement of sensitivities as low as 1 microvolt.

Size: Panel 8" x 11"; depth 22".

Net Weight: 44 pounds. Shipping Weight: 85 pounds.

Data subject to change without notice.

QUICKLY DETERMINES TYPE AND AMOUNT OF DISTORTION

The *-hp-* Model 320 Distortion Analyzer is a simple and convenient device for studying and measuring the total harmonic distortion in audio frequency apparatus. The character and type of distortion can also be determined.

The Model 320 contains a 70 db attenuator set and sharply tuned filters. Distortion measurements are made by eliminating the fundamental from the applied voltage with the filter and noting the amplitude of remaining distortion on an external detector or voltmeter such as the *-hp-* 400A. The filters are then switched out and the original wave attenuated on the self-contained attenuators until an identical reading is obtained on the external detector. The setting of the attenuator then indicates the distortion level in db below the applied wave. An oscilloscope also may be used to aid in determining the character of distortion or as a detector.

The Model 320 is available as the *-hp-* 320A, for measurements at 400 and 5000 cps; or as the *-hp-* 320B for frequencies of 50, 100, 400, 1000, 5000 and 7500 cps. Filters for other frequencies available on special order.

USES

These time-saving instruments are designed to quickly compare wave distortion with fundamental voltage, observe type as well as amount of distortion, obtain speed production testing. They will also attenuate voltages and signals through a range of 0 to 70 db.

SPECIFICATIONS

Frequency Range: Model 320A: 400 and 5000 cps. Model 320B: 50, 100, 400, 1,000, 5,000, 7,500 cps. (Filters for other frequencies on special order.)

Input Impedance: Minimum, 20,000 ohms.

Attenuator: 70 db adjustable in 1 db steps.

Distortion Range: Distortion as low as 0.1% of fundamental may be measured with sensitive detector.

Mounting: Wrinkle gray panel, oak cabinet: 13" long, 9" high, 8" deep. Relay-rack: 19" long, 9" high, 8" deep.

Net Weight: 17 pounds. Shipping Weight: 29 pounds.

Data subject to change without notice.



MODEL 330B

DISTORTION ANALYZER



ADVANTAGES:

- Blankets audio spectrum
- Measures noise as small as 100 microvolts
- Terminals for oscilloscope
- Micro-drive tuning control
- High accuracy, stability

USE IT FOR:

- Measuring total audio distortion
- Measuring voltage level, power output, amplifier gain
- Measuring total distortion of audio-modulated r-f carrier
- Measuring noise and hum level directly
- Determining audio signal frequency
- High-gain, wide-band stabilized amplifier

ACCURATE DISTORTION MEASUREMENTS 20 CPS TO 20,000 CPS

THE *hp*-Model 330B Distortion Analyzer is capable of measuring distortion at any frequency between 20 cps and 20,000 cps. It will make noise measurements of voltages as small as 100 microvolts. A linear r-f detector makes possible measurements of these characteristics direct from a modulated r-f carrier. The convenience of operation, high sensitivity, accuracy, stability and light weight of the *hp*-330B make it a uniquely valuable instrument for broadcast, laboratory and production measurements.

The circuit of the Model 330B consists of a linear r-f detector, a frequency-selective amplifier, a vacuum tube voltmeter, and a regulated power supply.

The r-f detector includes a diode rectifier operating in conjunction with a resonant circuit which is tuned to the carrier frequency under measurement. The detector covers a range of 500 kc to 60 mc, and is varied by means of a tuning condenser and range switch which selects one of six bands. The detector may be switched out of the circuit when audio frequencies are used.

ALMOST INFINITE ATTENUATION

The 20 db amplifier operates in conjunction with the *-hp*-resistance-tuned circuit to provide infinite attenuation at one frequency while allowing all other frequencies to be passed at the normal gain of the amplifier. (See Fig. 1.) Negative feedback is employed in the amplifier to minimize distortion, give a uniform response over a wide range of frequencies, and to provide a high order of stability. Frequency response is from 10 cps to 100,000 cps; thus even the 5th harmonic of 20 kc is passed by the amplifier without appreciable attenuation.

The voltmeter section of the instrument consists of a two-stage high-gain amplifier, a rectifier, and an indicating meter. A large amount of negative feedback is employed to insure stability and a uniform response from 10 cps to 100,000 cps. It responds proportionally to the average value of the applied voltage wave and is calibrated in rms values of a sine wave.

OTHER *-hp*- DISTORTION ANALYZERS

Model 330C Distortion Analyzer

The *-hp*- 330C Distortion Analyzer is a special modification of the *-hp*- 330B. It is identical in all respects, except that the indicating meter movement is provided with VU ballistic characteristics to meet F.C.C. requirements for FM broadcasting, and the AM diode detector is removed. Like the 330B, the Model 330C provides almost infinite attenuation at any one frequency, and makes possible "total" audio distortion measurements at any frequency from 20 to 20,000 cps.

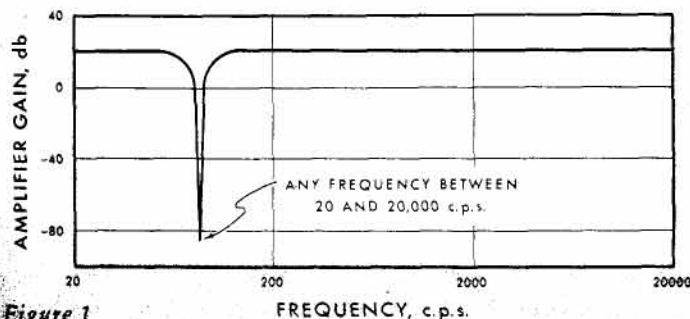

Figure 1

Model 325B Distortion Analyzer

The *-hp*- Model 325B is a combination of a frequency elimination circuit, an input amplifier (stabilized at 20 db) and a vacuum tube voltmeter. By eliminating the fundamental and measuring the residual, this instrument makes possible fast, accurate measurement of total noise and distortion. The Model 325B covers the audio spectrum with filters for: 30, 50, 100, 400, 1,000, 5,000, 7,500, 10,000 and 15,000 cps. Filters for other frequencies are available on special order. Full details on request.

SPECIFICATIONS

Model 330B Distortion Analyzer

Range: 20 cps to 20,000 cps. Frequency of measurement is selected on a directly calibrated dial having its lowest range calibrated directly in cps. Range switch selects operating band.

Accuracy: Circuit will eliminate fundamental by more than 60 db and will attenuate second and higher harmonics by less than 10%. Distortion measurements are accurate within $\pm 3\%$ of full scale reading for distortion levels as low as 0.5%. Meter indicates in proportion to the average value of the residual components. Residual distortion introduced by instrument is less than 0.1%.

Sensitivity: Distortion levels of 0.3% are measured full scale. Levels of 0.1% can be read with good accuracy at approximately 25% scale reading.

Voltmeter Range: Nine ranges. Full scale sensitivities of .03, .1, .3, 1.0, 3.0, 10, 30, 100, 300. Calibration $+2$ to -12 db is also provided. Ranges are related to each other in 10 db steps. Range switch indicates db level as well as voltage range. Zero level 1 milliwatt in 600 ohms.

Voltmeter Accuracy: $\pm 3\%$ of full scale; unaffected by changing of tubes or line voltage variations from 105 to 125 volts. Reading is proportional to average value of the applied wave, and is calibrated in rms value of a sine wave. This meter provides the most practical method of measuring distortion even though it does not indicate true rms values. It is stable, accurate and cannot be damaged by overloads.

Voltmeter Frequency Response: Flat within 3% over range of 10 to 100,000 cps.

Noise Measurement: When used to measure hum or noise meter will give a full scale deflection on a signal of 300 microvolts. Satisfactory readings may be made to 80 db below 1 milliwatt in 600 ohms.

R. F. Detector: Linear r-f detector is provided to rectify the transmitted carrier. Input circuits of this rectifier are tunable from 500 kc to 60 mc, in 5 bands.

A. F. Input Impedance: Input impedance at the audio frequency input terminals is approximately 200,000 ohms shunted by 40 uuf. Input impedance at the vacuum tube voltmeter terminals is 1 megohm shunted by 37 uuf.

Oscilloscope Terminals: Terminals are provided for connection to an oscilloscope to observe the wave shapes of the original signal and the residual distortion components. Maximum gain from the a-f input is 75 db.

Power Supply: 115 volt 50/60 cycles. Power consumption is 90 watts. Plate supply electronically regulated.

Mounting: Oak cabinet or relay rack. Panel size, 19" x 10½"; depth 13". Panel finish wrinkle gray.

Net Weight: 50 pounds. Shipping Weight: 120 pounds.

Data subject to change without notice.



MODEL 300A

HARMONIC WAVE ANALYZER

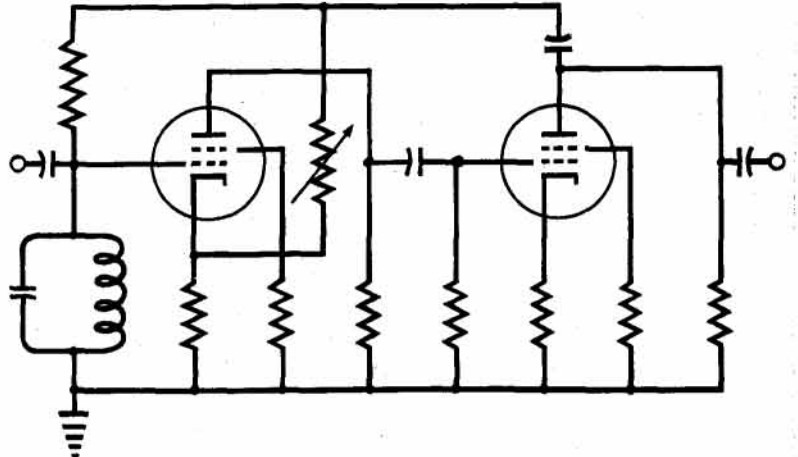
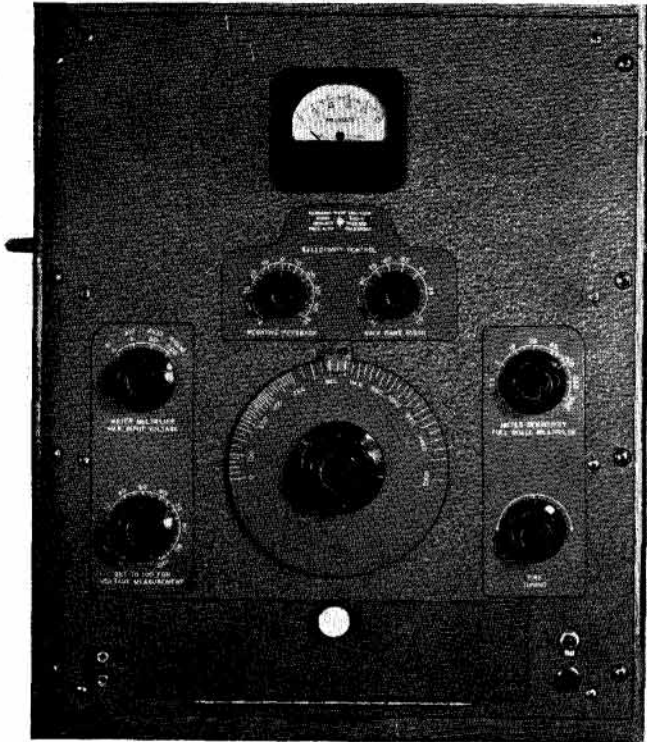

VARIABLE SELECTIVITY PROVIDES RAPID, ACCURATE WAVE ANALYSIS

THIS *-hp-* Model 300A Harmonic Wave Analyzer is a selective voltmeter designed to measure the individual components of complex waves. The selectivity can be varied by means of a unique selective amplifier. Where the harmonics are close together the high selectivity easily separates the wave components. Yet, where the components are spaced far apart, the selectivity may be widened to increase the speed of operation without sacrificing essential accuracy. This feature is also valuable where it is necessary to measure distortion of waves containing a small amount of frequency modulation, such as in sound tracks, and may be used conveniently to integrate a small portion of the audio spectrum in noise measurements and the like. Maximum selectivity is sufficient to separate harmonic components spaced 30 cycles apart. See figure 1.

DIRECT READING

The *-hp-* Model 300A Harmonic Wave Analyzer covers the audio spectrum from 30 cps to 16,000 cps. The wide voltage range covers the values encountered in nearly every application. Full scale voltmeter readings may be obtained with inputs of .001 to 500 volts so that the instrument may be used

ADVANTAGES:

- Direct reading
- Simplified operation
- Variable selectivity
- Wide voltage range
- Linear meter scale

USE IT TO ANALYZE:

- Noise characteristics
- Broadcast amplifier characteristics
- Modulating amplifier distortion
- Recording devices
- Rotating machinery harmonic voltages
- Film sound track distortion
- Recording distortion
- Hum
- Network characteristics

with equal success with low output transducers and high power modulating amplifiers. Other features which make it unexcelled for both laboratory and production testing are the linear meter scales fully protected against overloads, and the built-in calibrating system to standardize voltage measurements.

THEORY

The circuit of the Model 300A consists of a variable local oscillator, a balanced modulator, a selective amplifier, and an indicating meter. The variable local oscillator modulates the unknown frequency to produce a constant difference frequency. This difference frequency is applied to the selective amplifier, the output of which is then proportional to the magnitude of the unknown voltage. A meter in the output of the selective amplifier indicates the magnitude of the voltage.

The local oscillator is of the resistance-tuned type, providing a very stable, accurate voltage. A balanced modulator is used to eliminate the local oscillator frequency and to keep cross-modulation products very low. The selective amplifier consists of four tuned circuits in which the effective Q is controlled by positive feedback. Negative feedback is also used to stabilize the amplifier.

This amplifier has the unique characteristic that its selectivity may be varied over a wide range without appreciably affecting the gain of the amplifier.

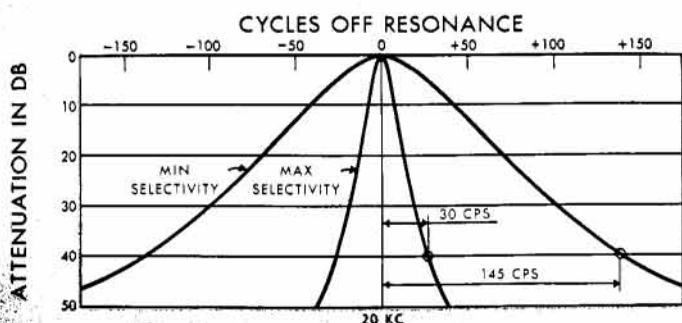

Figure 1

USES

The Model 300A is well adapted to the measurement of the harmonic distortion in audio frequency equipment of all kinds, broadcast receivers, transmitters; to determine the harmonic components in a-c machinery and power systems; to the study of induced voltages on telephone lines; to measurement of hum components in rectifier circuits.

Other uses include the study of noise by integrating portions of the spectrum with the selectivity control adjusted for a wide pass band and the checking of wave filter characteristics with maximum selectivity.

The Model 300A is also useful as a device to measure the amount of cross- or inter-modulation products generated by the simultaneous transmission of two frequencies by an audio system or to measure demodulation of a modulated wave applied through an audio system.

SPECIFICATIONS

Frequency Range: The frequency range is from 30 to 16,000 cps and the frequency calibration is within 3%. The frequency is controlled by a 7" diameter dial located on the panel. The entire range is covered in approximately a 200° sweep of the dial.

Voltage Range: There are four input voltage ranges having maximum values of 0.5 volts, 5 volts, 50 volts, and 500 volts. In addition, a meter multiplier divides each voltage range into full scale meter readings of 500, 250, 100, 50, 25, 10, 5, 2.5, and 1. Thus full scale meter readings can be obtained on from 1 mv to 500 v. Two controls select the input range and meter multiplier. The linear meter is fully protected against overloads.

Selectivity: The selectivity can be varied by means of a control on the front panel. At the maximum selectivity setting, the response is down approximately 3 db at 3.5 cycles, 10 db at 8 cycles, 40 db at 30 cycles, and 60 db at 53 cycles from maximum response. At minimum selectivity the response is down approximately 3 db at 14 cycles, 10 db at 37 cycles, 40 db at 145 cycles, and 60 db at 280 cycles from maximum response. Selectivity may be varied continuously between these limits. The variable selectivity control is calibrated in the half band width at which the response is down 40 db.

Voltage Accuracy: The over-all voltage accuracy is $\pm 5\%$, provided adjacent harmonics are within limits determined by the selectivity. This accuracy can be maintained provided that unwanted voltages are attenuated by the selectivity of the instrument to less than $\frac{1}{3}$ of the voltage being measured. Thus, with maximum selectivity a 3% second harmonic of a 30 cycle voltage may be measured with 5% accuracy.

The residual modulation products are suppressed by at least 65 db. Hum is at least 75 db below maximum input voltage on any of the four input ranges.

Input Impedance: The input impedance is 200,000 ohms. The input circuit includes a potentiometer which is set to maximum for voltage measurements.

Power Supply: The instrument contains a voltage regulated power supply which operates from 115 volts, 50/60 cycles. Power required is 105 watts.

Mounting: The Model 300A is mounted in an attractive oak cabinet to harmonize with the panel which is finished in wrinkle gray with machine engraved designations. A relay rack model is also available and is designated as the Model 300AR.

Physical: Over-all dimensions of the Model 300A are 24" high, 21 $\frac{5}{8}$ " wide, and 14 $\frac{1}{8}$ " deep.

Net Weight: 78 pounds. Shipping Weight: 150 pounds.

Data subject to change without notice.



MODEL 400 A VACUUM TUBE VOLTMETER



ADVANTAGES:

- Wide voltage range. High sensitivity
- Hairline accuracy. Time saving stability
- High input impedance
- Large overvoltage capacity
- Waveform errors minimized
- Measurements up to 1 mc
- Small and light

USE IT TO MEASURE:

- Voltage in audio, supersonic, and lower RF region
- Amplifier gain. Network response
- Output level. Hum level
- Power circuit voltages
- Video voltages. Carrier current voltages
- Capacity. Coil figure of merit

MEASUREMENTS UP TO 1 MC SIMPLY AND ACCURATELY MADE

OR MANY YEARS the advantages of vacuum tube voltmeters have been recognized by electronic workers. The *hp*-Model 400A Vacuum Tube Voltmeter is unusually flexible because of its wide frequency and voltage ranges. A-c voltages as small as .005 and as high as 300 volts can be simply and directly measured without any precautions over a frequency range of 10 cycles to 1,000,000 cycles. Accuracy of readings is assured because the high input impedance does not disturb the usual circuit under test. Furthermore, the calibration error of the instrument under all conditions is less than 3% to 100 kc and less than 5% to one megacycle.

BROAD BAND AMPLIFIER

This circuit consists of a high gain amplifier and a full wave rectifier. A unique input circuit provides an input impedance of 1 megohm and low shunt capacity. The full wave rectifier actuates a one-mil meter. The amplifier is of the broad band type and is substantially flat from 10 cps to one mc. Because the amplifier employs inverse feedback, it

is extremely stable. Thus the accuracy of meter reading is virtually independent of line voltage changes and tube characteristics. See figure 1.

EASY TO OPERATE

The simplicity of operation characteristic of all *-hp-* instruments is exemplified by the Model 400A Vacuum Tube Voltmeter. Ordinarily, no precautions whatsoever are required. Turnover effect and waveform errors are minimized because this meter responds to the average value of the full wave. There are no adjustments to make during operation. Large overload voltages cause saturation of the amplifier which protects the meter from damage. Thus occasional overloads of 100 times normal will not damage the meter movement.

USES

The speed and accuracy of measurement of this meter make it invaluable for laboratory work in measuring amplifier gain, network response, and output level. The wide frequency range makes it suitable for video measurements as well as RF measurements. The sensitivity is sufficient to measure the hum level

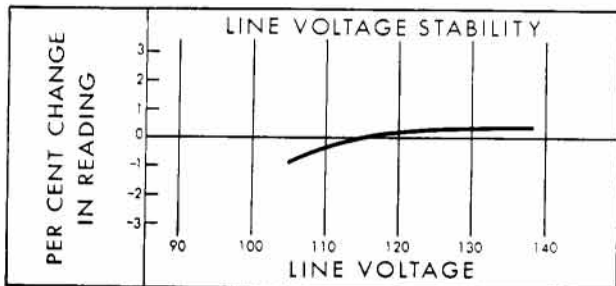

Figure 1

directly in many cases. The higher voltage ranges are useful for measuring power circuit voltages and high frequency voltages in broadcast equipment. It is also valuable as a VU meter, to measure coil Q, compare capacities and resistances, and as a null detector.

CONVENIENT TO USE

From the purely physical standpoint, the *-hp-* 400A is unusually convenient to use because of its small size and large, easily-read slanting scale. See figure 2. The power supply is completely contained. No adjustment to zero position is required, and the ranges are instantly available by means of a switch on the panel. The meter is calibrated in decibels as well as in volts and each voltage range is related to the next by 10 db steps. Thus any db level may be read directly. All in all, the *-hp-* Model 400A is probably one of the most useful instruments in the field of electronic laboratory equipment.

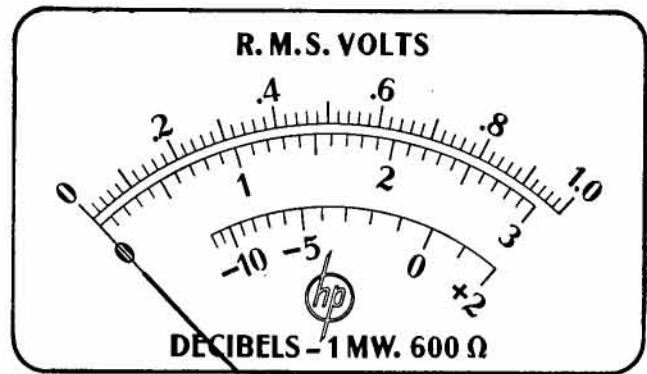

Figure 2 · Detail of Meter Face

SPECIFICATIONS

Voltage Range: A switch on the front panel selects nine voltage ranges having full scale sensitivities of .03 volts, 0.1 volts, 0.3 volts, 1.0 volts, 3.0 volts, 10.0 volts, 30.0 volts, 100 volts, 300 volts.

Calibration: The meter is calibrated to read the rms value of a sinusoidal wave. The voltage scale is linear and a decibel calibration based on 1 milliwatt in 600 ohms is provided. The indication is in proportion to the average value of the full wave; thus waveform errors and turnover are minimized.

Frequency Range: The frequency range is 10 cps to 1 mc.

Accuracy: The over-all accuracy of the meter is within $\pm 3\%$ below 100 kc and $\pm 5\%$ from 100 kc to 1 mc. Line voltage variations from 105 volts to 125 volts or changing tubes will affect the reading by less than 3% at all frequencies below 100 kc.

Input Impedance: The input impedance is equivalent to 1 megohm shunted by 16 uufd on the 30 volt range and below. On the 100 volt range: 3 megohms, and on the 300 volt range: 2.4 megohms.

Overvoltage Capacity: Occasional overloads of 100 times normal will not damage the meter movement. Continuous or frequent overloads should be avoided.

Power Supply: The instrument operates from 115 volts, 50/60 cycles, 40 watts.

Mounting: The meter is mounted in a steel cabinet finished in wrinkle gray. The front panel is finished in a satin gray baked enamel, with photo-etched designations. The cabinet is 7½ inches wide, 8 inches high, and 9 inches deep. A leather handle is provided at the top of the cabinet.

Net Weight: 15 pounds. Shipping Weight: 20 pounds.

Data subject to change without notice.

hp MODEL 410A

HIGH FREQUENCY VACUUM TUBE VOLTMETER



ADVANTAGES:

- Range: 20 cps to 700 mc
- Input capacity, approximately 1.3 mmfd
- High input impedance
- Few controls. High stability
- Rugged meter movement
- Excellent overload protection

USE IT TO MEASURE:

- Audio frequency, supersonic, r-f, and VHF voltages
- Antenna voltage, current, and power
- Transmission line characteristics
- Standing waves
- Audio, video and VHF amplifiers
- DC voltage in high impedance circuits

ALL-PURPOSE TEST INSTRUMENT MEASURES TO 700 MC

BECAUSE of the tremendous number of tasks it will perform, the 410A High Frequency Vacuum Tube Voltmeter can play a uniquely valuable role in any laboratory, broadcast station, or production test department. It combines in one instrument an ac voltmeter covering the frequency range from audio to radar frequencies, a dc voltmeter with 100 megohms input impedance, and an ohmmeter capable of measuring resistance from 0.2 ohms to 500 megohms. In addition, it is easy to use, compact, portable, and light in weight.

A special probe, employing a new, radically different diode especially designed by Eimac for Hewlett-Packard, is used for making ac measurements. The resonant frequency of the diode is approximately 2000 mc, and the shunt capacity is extremely low. Mounted in the probe, it places a capacity of

approximately 1.3 mmfd across the circuit under test. Total input impedance at low frequencies for ac measurements is 10 megohms shunted by this capacity.

The 410A employs a high impedance dc voltmeter having a special circuit developed by *-hp-* engineers. Its outstanding feature is low drift and maintenance of calibration over long periods of time. Only one zero adjustment is necessary for all voltage ranges, and once set it rarely needs readjustment. This circuit permits the use of a 1 ma meter movement which together with certain features of the circuit itself makes it impossible to damage the meter by overloads. Input impedance for dc measurements is 100 megohms for all ranges.

USES

The versatility of the 410A is so great that the number of uses to which it may be put is almost endless. As an ohmmeter it will accurately measure resistance over a much wider range than is ever ordinarily encountered. As a dc voltmeter, its extremely high input impedance permits its use on almost any equipment without any appreciable loading of the circuit.

Accuracy: $\pm 3\%$ of full scale on all ranges on sinusoidal ac voltages and on dc voltages. The ac portion of the instrument is a peak-reading device, calibrated in rms volts.

Frequency Response: Frequency response is flat within ± 1 db up to 700 mc and drops off less than 1 db at 20 cps. Probe resonant frequency is about 2000 mc, and an indication can be obtained up to 3000 mc. See Fig. 2.

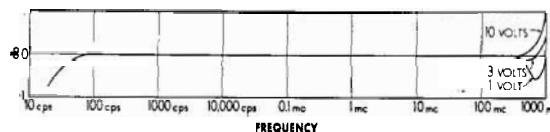

Figure 2. Frequency response

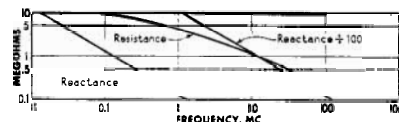

Figure 3. Input characteristics

Input Impedance: Input capacity is 1.3 mmfd; input resistance is 10 megohms at low frequencies. At high frequencies resistance drops off due to dielectric losses. (See Fig. 3.) Dc input resistance is 100 megohms for all ranges.

Probe: The probe is approximately 1" diameter and $4\frac{1}{2}$ " long. It is equipped with a ground clip, and the connector may be soldered to the point under test. For operation at lower frequencies the probe can be mounted in the storage compartment and connections made to binding posts on the panel. Adapting connectors are available to measure voltages in coaxial transmission lines.

Power Supply: 115 volts, 50/60 cycles, 40 watts. Two $1\frac{1}{2}$ volt flashlight cells provide ohmmeter circuit voltage.

Mounting: Gray panel. Wrinkle gray finished metal case. Size $12\frac{1}{8}$ " x $7\frac{5}{8}$ " x $6\frac{1}{4}$ ".

Net Weight: 16 pounds. Shipping Weight: 23 pounds.

Data subject to change without notice.

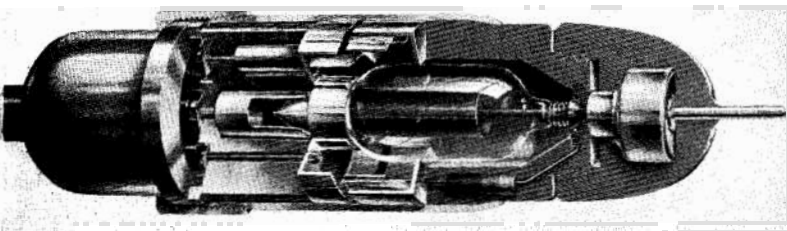

Figure 1. Construction details of new *-hp-* diode probe

As an ac voltmeter, its combination of high input impedance with great frequency range sets altogether new standards of performance. The probe can be inserted in almost any audio, supersonic, radio, or VHF amplifier without detectable loading of the circuit. It can be used to measure antenna and transmission-line voltage, current, and power with as much ease and convenience as if the circuits carried dc. Special adaptors can be supplied for use with the probe to connect to standard transmission lines.

Finally, the fact that all these functions are combined in one instrument means that where previously a whole battery of equipment might be required to test a given piece of apparatus, the 410A, in one small, convenient, and highly portable instrument, does the whole job. Leads are provided for all functions so that to change from one to another it is necessary only to throw a switch.

SPECIFICATIONS

Ranges: 1 to 300 volts in 6 ranges full scale: 1, 3, 10, 30, 100, and 300 volts ac or dc and 0-1000 volt range dc. Resistance 0.2 ohm to 500 megohms in seven ranges. Mid-scale reading of 10, 100, 1000, 10,000, 100,000 ohms, 1 megohm, and 10 megohms.

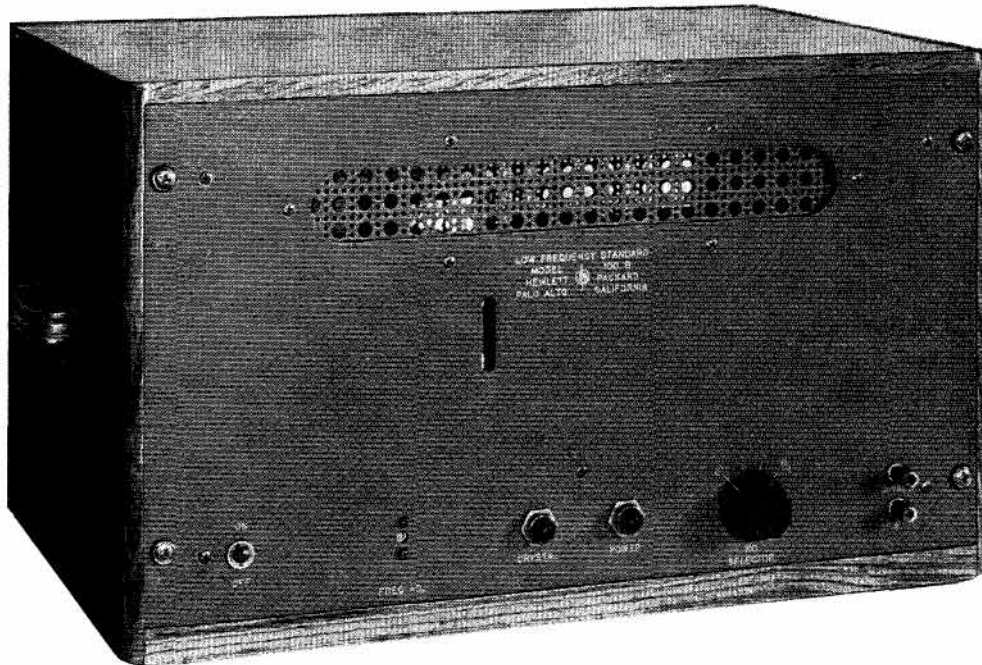
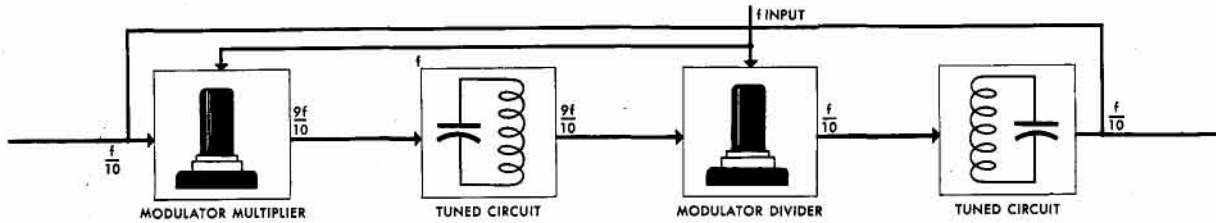

Figure 4. Probe is compact for greater ease in reaching components



MODEL 100B

SECONDARY FREQUENCY STANDARD



GENERATES FOUR STANDARD FREQUENCIES

ADVANTAGES:

- Supplies standard frequencies, 100 cps, 1 kc, 10 kc, and 100 kc
- Frequencies available simultaneously
- Stable operation
- Sinusoidal wave shape
- Separate terminals for each frequency
- Low output impedance

USE IT FOR:

- Calibrating audio oscillators
- Calibrating supersonic oscillators
- A time standard
- Checking oscillator stability

THE Model 100B Secondary Frequency Standard provides an extremely useful and convenient source of standard frequencies of 100 cps, 1 kc, 10 kc, and 100 kc. It is an accurate laboratory standard for calibration and comparison purposes.

The circuit of the Model 100B consists of a 100 kc crystal controlled oscillator and three frequency divider circuits which divide in a ratio of 10 to 1. The fundamental divider circuit consists of a modulator divider tube with a resonant circuit tuned to $f/10$ and a modulator multiplier tube with a resonant circuit of $9f/10$.

The operation of the circuit can be explained by assuming a small voltage in the resonant circuit of the modulator divider tube. This voltage is applied to the grid of the modulator multiplier tube, and the input control voltage is also applied to this tube. The two voltages mix to supply an output frequency of $9f/10$, which is fed to the grid of the modulator

tube where it is mixed with the input control frequency (f), and results in a frequency of $f/10$ in the modulator divider tuned circuit. The action is repeated and the voltage is built up until a stabilized condition is reached. Thus the output of the divider unit is controlled by the input frequency.

By cascading the 100 kc generated by the temperature-controlled oscillating quartz crystal down through three dividers, accurate fixed frequencies of 10 kc, 1 kc, and 100 cps are also made available. See figure 1.

USES

These frequencies are available through a selector switch (on front of panel) or individually from binding posts (rear of chassis). All four fixed frequencies can be utilized at separate test stations simultaneously, an economical feature.

The Model 100B provides four standard frequencies for accurate measurement purposes such as for calibrating oscillators, frequency meters and supplying test signals of high accuracy. The output wave shape is sinusoidal which will allow easy recognition of high fractional Lissajous patterns such as $53/5$ or $52/5$. Thus exact measurements can be made of frequencies 1% or 2% apart in the audio spectrum, and up to 100 kc. With a distorting amplifier and a conventional mixer system harmonics may be obtained for frequency calibration to 20 megacycles or higher, even though the waveform of the standard is sinusoidal.

The output system is designed to isolate each frequency. The internal impedance of the output system is sufficiently low to permit the use of long lengths of low capacity shielded cable to distribute the standard frequencies in the laboratory or the test department.

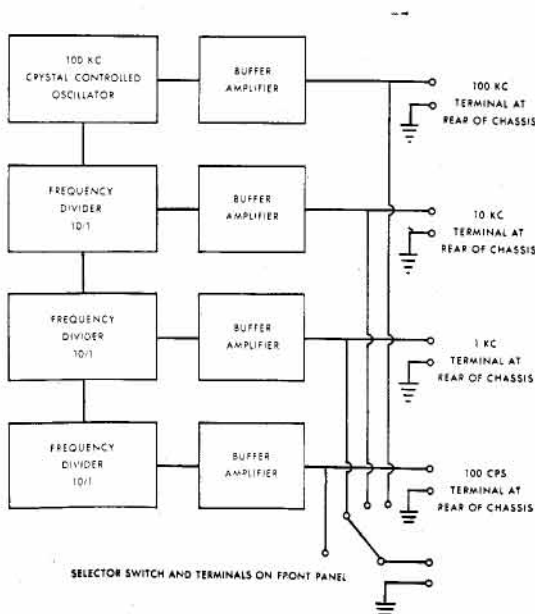

Figure 1

SPECIFICATIONS

Two models are available. The 100B which has a temperature controlled oscillating quartz crystal, and the Model 100A which is similar to the 100B but does not have temperature control.

Accuracy: The Model 100A is provided with a 100 kc crystal having a temperature coefficient of 3 cps per megacycle per degree centigrade. The crystal oscillator is arranged so that the frequency can be adjusted over a range of approximately ± 8 cps at 100 kc. This feature allows the frequency to be set to a primary standard such as National Bureau of Standards Station WWV.

The Model 100B is provided with a temperature controlled crystal which maintains the frequency within $\pm .001\%$ over normal room temperatures. It is also possible to adjust the frequency of the Model 100B approximately ± 8 cps at 100 kc.

Output: An output voltage of at least 5 volts is provided on all frequencies. The internal impedance of the output system is approximately 200 ohms and satisfactory wave shape can be obtained with a load impedance as low as 1000 ohms.

Wave Shape: The output wave shape is sinusoidal to a degree that will allow easy recognition of high fractional Lissajous patterns such as $53/4$ or $52/5$. Thus, exact measurements can be made at frequencies 1% or 2% apart in the audio spectrum, and up to 100 kc. With a suitable distorting amplifier and mixing system harmonics may be obtained for frequency calibration to 20 megacycles or higher.

Power Supply: The Standard operates from 115 volts 50/60 cycle power supply, and the power supply is regulated to minimize line voltage fluctuation effect. Power drawn is approximately 105 watts.

Mounting: The Model 100 is available in either cabinet or relay rack mounting. The panel size is $19'' \times 10\frac{1}{2}''$, and the depth is $12''$.

Net Weight: 53 pounds. Shipping Weight: 95 pounds.

Note: When ordering specify if temperature control of the crystal is desired; otherwise, specify ambient temperature at which crystal frequency should be set.

Data subject to change without notice.

SUPPLEMENTARY FREQUENCY DIVIDER

The Model 110 Frequency Divider Panel is for use in conjunction with Models 100A or 100B to supply frequencies not ordinarily generated by these instruments. The Model 110 can be supplied to generate frequencies between 10 and 100 cycles per second, or between 100 and 1 million cycles per second. The Model 110 Frequency Divider Panel is supplied only on special order to meet particular requirements.



MODEL 350

ATTENUATORS AND VOLTAGE DIVIDERS

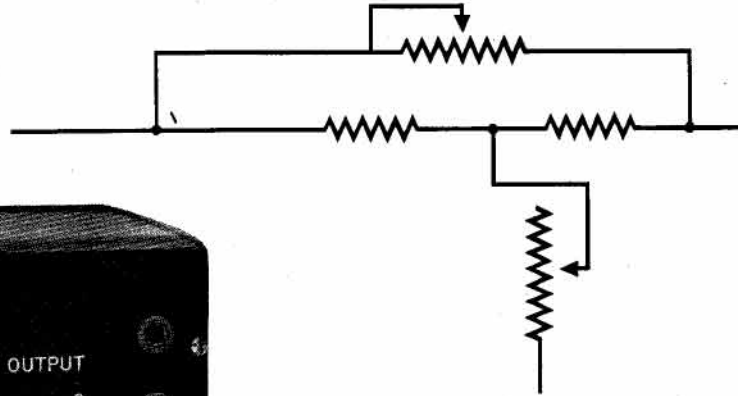

ADVANTAGES:

- Accurate
- Large power handling capacity
- Wide frequency response
- Smooth operation
- Convenient controls

USE IT TO:

- Attenuate the output of supersonic and audio oscillators
- Measure gain and frequency response of amplifiers
- Measure transmission loss
- Increase usefulness of other laboratory instruments

A SMALL INSTRUMENT WITH MANY USES

FOR measurement work where accuracy, wide frequency response, large power handling capacity, or other special features are desired, *hp*-attenuators and voltage dividers are extremely valuable. Typical of these highly specialized instruments is the *hp*- Model 350 Attenuator Set.

The schematic diagram above shows the basic bridged-T circuit, two of which make up the *hp*- 350 Attenuator Set. One is a 100 db attenuator, calibrated in 10 db steps, and one is a 10 db attenuator, calibrated in 1 db steps.

A special design assures a response that is substantially flat to frequencies as high as 100 kc. See figure 1. Calibration is accurate because the individual resistors are adjusted to $\pm 1/2\%$.

USES

The *hp*- Model 350 can be used wherever a decade attenuator is required.

In conjunction with an *hp*- oscillator and one voltmeter, this *hp*- Model 350 Attenuator may be used to make exact measurements of power gain. See figure 2.

The 350, like all *-hp-* instruments, is held to a minimum lator and a vacuum tube voltmeter (*-hp-* 400A) to form a signal generator. See figure 3.

The 350 is built with a large power handling capacity—5 watts continuous duty. It is particularly adapted to work in the supersonic field, and for other work in measurements above the range of the conventional a-f attenuator. It may also be used for work down to zero frequency.

The 350 may also be used to augment an *-hp-* audio oscillator for convenience in use. Actual dimensions are 5" x 8" x 4½". Input and output binding posts are available on the front panel. The unit is completely shielded from moderate fields.

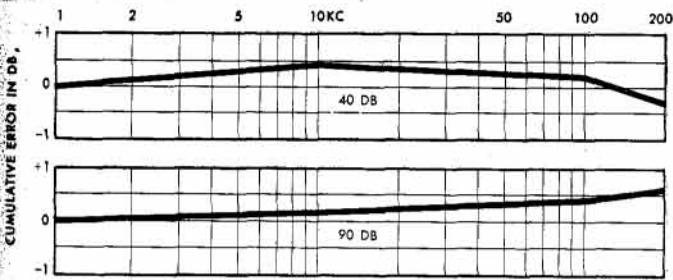

Figure 1. Typical Frequency Response

SPECIAL PROBLEMS

Attenuators, voltage dividers, matching networks, and precision resistors accurate for frequencies as high as one megacycle can be supplied. Inquiries pertaining to your particular measurement problem will be given prompt attention.

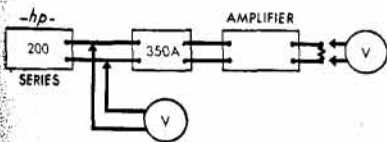

Figure 2

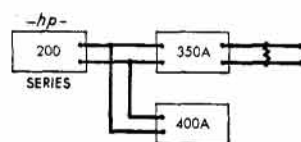

Figure 3

SPECIFICATIONS

Two models are available. The *-hp-* 350A matches a 500 ohm impedance and the *-hp-* 350B matches a 600 ohm impedance (one side grounded).

Attenuation: The attenuation is 110 db in 1 db steps.

Accuracy: Each individual resistor is adjusted to $\pm 1\frac{1}{2}\%$.

Frequency Response: Accumulative error at 100 kc less than 1 db in 50 db.

Power Capacity: 5 watts, continuous duty.

Mounting: Gray panel. Oak cabinet: 5" x 8" x 4½".

Net Weight: 4 pounds. Shipping Weight: 8 pounds.

Data subject to change without notice.

SPECIAL -hp- HARDWARE

Precision multi-tap switches and other hardware for use in equipment for measuring work are also available. Two typical examples of this special-purpose hardware are shown below.

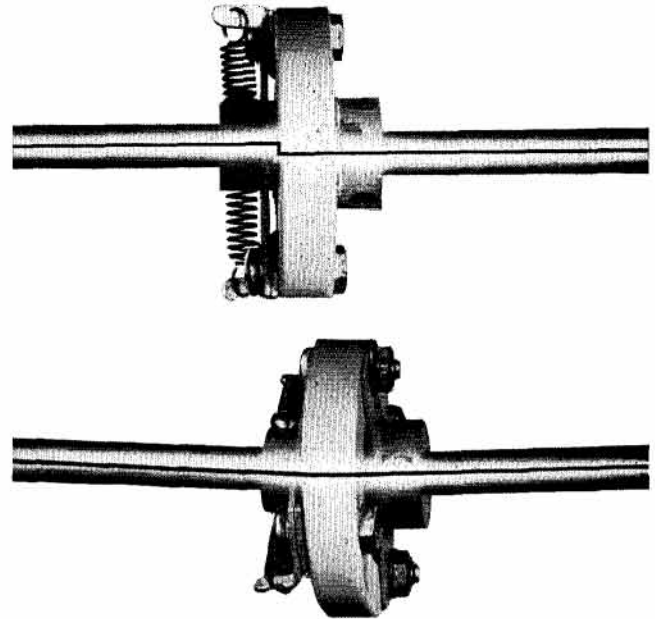

FLEXIBLE COUPLER

The *-hp-* flexible coupler permits the accurate, positive transmission of motion from one shaft to another when the two shafts are not accurately aligned. Misalignments of as much as ⅓" and/or 5° are permissible. At the same time, the two shafts are insulated from each other, each shaft being connected to a different point on the ceramic body of the coupler. The coupler is spring-loaded to prevent backlash.

BINDING POSTS

The *-hp-* No. 10 binding posts shown, were designed to provide a positive connection that could be changed frequently. The recess for the "Banana" plug is in the main body

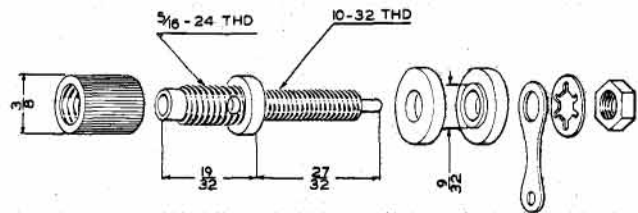

of the post, a feature which eliminates excessive contact resistance. The cross-hole for permanent connection can be used even when the "Banana" plug is inserted. The screw thread will not damage the thread. The long, axially-knurled ferrule is 10-32 and the tip is undercut so that a soldered connection provides a wide surface for ease of handling and adds to the appearance.



MODEL 450 A

AMPLIFIER



MODEL 710 A

POWER SUPPLY UNIT



GENERAL-PURPOSE AMPLIFIER 20 DB OR 40 DB GAIN

The *-hp-* Model 450A Amplifier is ideal as a general purpose instrument wherever wide frequency range and stable gain are essential. The instrument has an extremely stable 20 db or 40 db gain over a continuous frequency range of 10 cps to 1,000,000 cps. Either gain may be quickly selected with a toggle switch on the front panel.

The amplifier is resistance-coupled and does not use peaking or compensating networks. Optimum performance is obtained entirely from a straightforward amplifier design in combination with inverse feedback. Phase shift is negligible, and there are no spurious oscillations or resonances.

USES

The *-hp-* 450A Amplifier may be used separately for almost any amplification job or in conjunction with the *-hp-* 400A Vacuum Tube Voltmeter.

When used with the 400A Voltmeter, the 450A Amplifier increases voltmeter sensitivity 100 times at 40 db gain (300 microvolts full scale). At 20 db gain, the voltmeter's sensitivity is multiplied 10 times (3 millivolts full scale). Both amplifier and voltmeter have identical base sizes.

SPECIFICATIONS

Gain: 40 db (100X) or 20 db (10X) (Panel Switch).

Frequency Response: At 40 db gain: within $\pm 1/2$ db between 10 and 1,000,000 cps; within ± 1 db between 5 and 2,000,000 cps. At 20 db gain: within $\pm 1/2$ db between 5 and 1,000,000 cps; within ± 1 db between 2 and 1,200,000 cps.

Stability: $\pm 2\%$ with approximate line voltage variation 105-125 volts and normal change in tube characteristics.

Input Impedance: 1 megohm shunted by approx. 15 uuf.

Output: 10 volts maximum to 3,000 ohms or higher resistive load.

Internal Impedance: Less than 150 ohms over entire range.

Distortion: Less than 1% at max. output and rated load.

Equivalent Input Noise Level: 40 db gain, 30 microvolts approximate; 20 db gain, 150 microvolts approximate.

Power Supply: 115 volts 50/60 cycles 40 watts.

Mounting: Metal case, leather carrying handle.

Size: 7 $1/2$ " wide, 5 $1/4$ " high, 9 $1/2$ " deep.

Net Weight: 10 pounds. Shipping Weight: 18 pounds.

Data subject to change without notice.

HIGH-STABILITY REGULATED DC OR AC POWER SUPPLY

The *-hp-* Model 710A Power Supply is an excellent source of dc power for every laboratory and production department use. It has been designed to give the ultimate in flexibility, compactness, portability, and economy. Output is continuously variable between 180 and 360 volts, and is practically independent of either line voltage or applied load for any setting. The noise and hum level is very low for any condition of operation. The output is stable over long periods of time. Its small size requires a minimum of bench space when in use, and little storage space when idle. Since many set-ups which call for a source of well-regulated dc also require an ac source for supplying filaments, a center-tapped, 6.3 volt source which will supply 5 amps ac has been included. The low cost makes it practical and economical to employ several of these instruments simultaneously.

USES

Because of its stability and low noise level, the *-hp-* Model 710A Power Supply can be used in place of batteries in many applications. In such service its long life, dependability, and portability result in real savings, both in time and money. It

may be used to power low-level amplifiers, constant frequency oscillators, and any equipment requiring a voltage source of high stability. One of its outstanding uses is in supplying power for temporary set-ups, "breadboard" layouts, and the like, where its exceptional flexibility makes it applicable in countless ways.

SPECIFICATIONS

Voltage Range: Output continuously variable from 180 to 360 volts. Either positive or negative output terminal may be grounded. 6.3 volts ac, center-tapped, also provided.

Regulation: Output constant to approximately 1% for loads of from 0 to 75 ma, and line voltage variations of ± 10 volts for any setting. A maximum of 100 milliamperes can be drawn.

Noise and Hum: Total noise and hum is less than 0.005 volts for any condition of operation.

Input Power: 115 volts 50/60 cycles. 90 watts full load.

Mounting: Wrinkle gray finish. Panel size, 7 $1/4$ " x 8". Cabinet depth, 11 $3/4$ ".

Weight: 18 pounds. Shipping Weight: 25 pounds.

Data subject to change without notice.

hp MODEL 500A

ELECTRONIC FREQUENCY METER

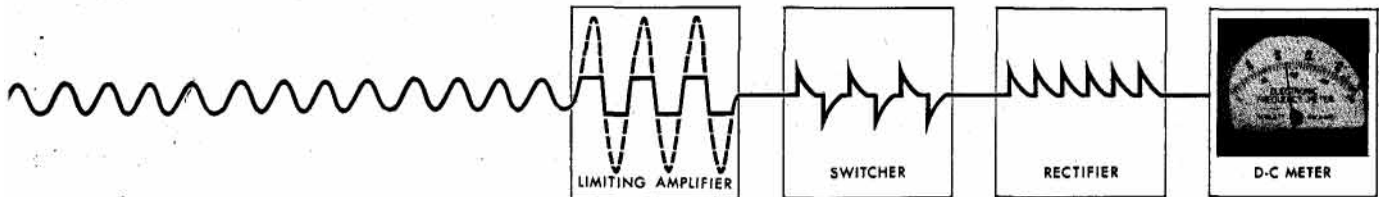

- Wide frequency range
- Accurate
- Good sensitivity
- Accuracy independent of line voltage changes and tube characteristics
- Ten convenient scale ranges

USE IT TO MEASURE:

- Beat frequency between two RF signals
- Crystal frequency deviation
- Audio frequencies
- Speed of rotating machinery
- Oscillator stability

MEASURES THE FREQUENCY OF A-C VOLTAGE AS HIGH AS 50 KC

THE *hp*-Model 500A directly measures the frequency of an alternating voltage from 5 cps to 50 kc. It is suitable for laboratory and production measurements of audio and supersonic frequencies.

The frequency meter consists of a wide band amplifier with a limiting circuit, an electronic switch, a constant current supply, a frequency discriminating circuit, and an output meter and rectifier. The input signal is amplified and used to switch the constant current source to alternate load resistors. The voltage developed across these resistors is applied to a condenser, and the output meter indicates the average value of the rectified charging current. (See diagram above.) The circuit is designed so that each pulse of charging current has the same average value, making the meter reading proportional to the number of pulses per second, and hence proportional to the frequency of the input signal.

INDEPENDENT OF SIGNAL VOLTAGE VARIATIONS

The reading is practically independent of the input voltage waveform, as normal waveform errors cannot affect the electronic switching operation. The regulated current source makes the reading independent of variations in input signal voltage, line voltage, and vacuum tube characteristics. A multiplier switch in the meter circuit provides ten convenient scale ranges. Provision is made for checking the calibration against power line frequency.

USES

The *-hp-* 500A will measure directly and without any precautions the frequency of any source in the audio and supersonic range. In frequency measurement work at higher frequencies, with the aid of a detector it can be used to measure the frequency difference between two radio frequency signals. It is particularly suited to crystal grinding work, where it can be used to measure the frequency deviation from the standard quickly and accurately. Similarly it may be used to measure oscillator and transmitter frequency stability. With the aid of a magnetic pickup it may be used to measure speed of machinery and rate of vibration. Provision is made to operate an Esterline-Angus 1 ma recorder with the Model 500A for a continuous record of frequency.

SPECIFICATIONS

Frequency Range: 5 cycles to 50 kc, in ten ranges having full scale values of 50, 100, 200, and 500 cycles, and 1, 2, 5, 10, 20, and 50 kc.

Input: An input voltage of at least 0.5 volts is required and the input impedance is 50,000 ohms. Variation of the input voltage from 0.5 volts to 200 volts will affect the reading of the meter by not more than plus or minus 1%. A push-button panel switch is provided to insure that sufficient signal voltage is present for proper operation.

Accuracy: The overall accuracy of the meter is plus or minus 2% of full scale value. A line voltage variation of from 105 volts to 125 volts will affect the meter reading by not more than plus or minus 1% of full scale.

Recorder Output: Jack provided on right-hand side of panel for use with 1 milliamper, 1400 ohm Esterline-Angus Automatic Recorder.

Power Supply: 115 volts, 50/60 cycles, 65 watts.

Mounting: The instrument is available in either cabinet or relay rack mounting. The panel size is 8 $\frac{3}{4}$ " x 19" and the depth is 12".

Net Weight: 28 pounds. Shipping Weight: 44 pounds.

Data subject to change without notice.

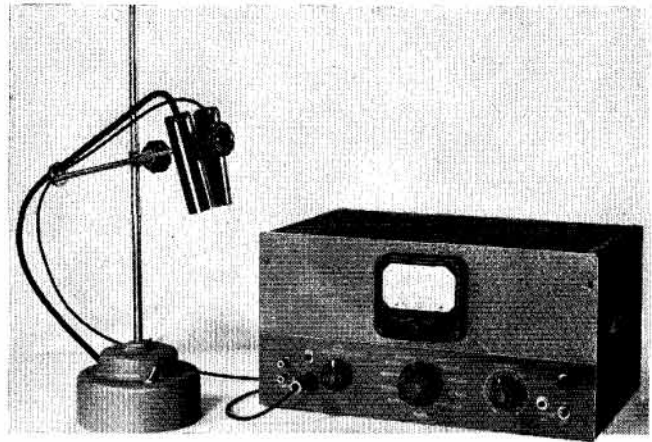

ELECTRONIC TACHOMETER

How to Count RPM Without External Loading

-hp- Models 505A and 505B Electronic Tachometers are a natural development from the 500A Electronic Frequency Meter. By connecting a photocell pickup in combination with a light source to this basic instrument, it becomes an electronic tachometer, capable of counting speeds or revolutions over a wide range, from about 300 rpm (5 cps) to 3,000,000 rpm (50,000 cps). The light illuminates the moving part to be measured, which is prepared with alternate reflecting and absorbing surfaces. The interrupted reflected light is picked up by the photocell; the electrical impulses generated thereby are transmitted to the frequency meter. The *-hp-* Electronic Tachometer is capable of measuring very high speeds of moving parts which have small energy or which for other mechanical reasons cannot be mechanically connected to any measuring device. The danger of fractional or multiple errors, inherent in other measuring methods, is eliminated.

SPECIFICATIONS

The Electronic Tachometer consists of a photocell and a light source mounted on a stand and an electronic frequency counter which is similar to the *-hp-* Model 500A. Two tachometer models are supplied. The *-hp-* Model 505A is calibrated in rpm and the *-hp-* Model 505B is calibrated in rps.

Speed Range: Model 505A: 300 rpm to 3,000,000 rpm full scale reading, in ten ranges. Model 505B: 50 rps to 50,000 rps full scale reading in ten ranges.

Circuit and Construction: Similar to *-hp-* Model 500A except for calibration.

Photocell: Type 1P41 phototube. Mounted in shielded tube same size as light source and provided with condensing lens to focus reflected light on phototube. Three-foot cable connects photocell to frequency meter.

Light Source: 21 candle power, 6 volt automotive bulb, mounted in shielded tube. Condensing lens concentrates light. Net Weight: 38 pounds. Shipping Weight: 50 pounds.



MODEL 335B

FREQUENCY MONITOR AND MODULATION METER

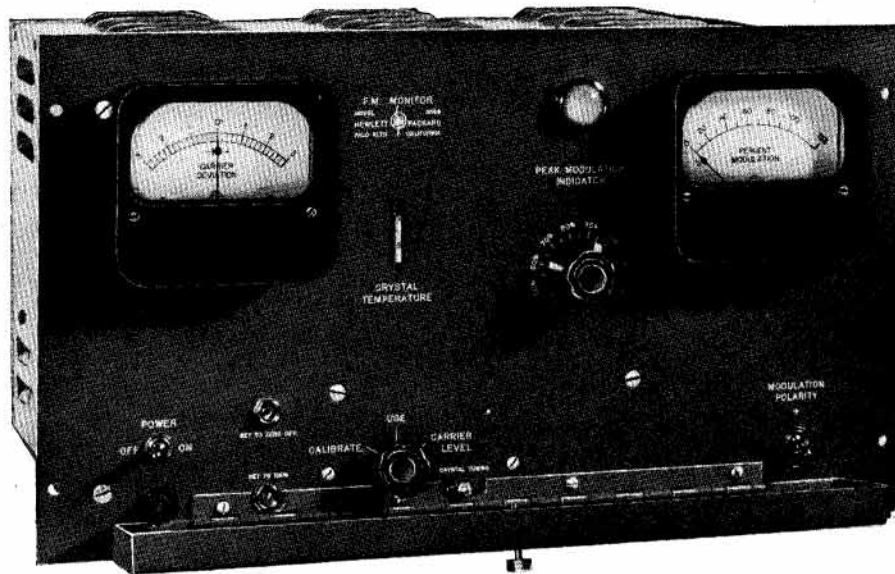

HIS NEW *-hp-* 335B Frequency and Modulation Meter monitors FM transmitters reliably, accurately, over long periods of time. No adjustments are necessary during operation, and because the instrument does not depend on a tuned circuit, it is not necessary to re-set the carrier level or re-align circuits. The instrument is specifically designed to operate without adjustment week after week. It gives continuous indication of broadcast frequency and of modulation level at all times, and has F.C.C. type approval.

A low-temperature coefficient crystal, oscillating inside a temperature-controlled oven, provides a reference standard of approximately 5 mc. The output of this crystal oscillator is multiplied 20 times, and mixed with the transmitter frequency to form a 200 kc intermediate frequency. This frequency is fed into electronic counter circuits, which measure the intermediate frequency and thereby indicate the carrier deviation. The linear counter circuits also provide a measurement of percentage modulation as well as an audio output signal for measurement and monitoring purposes. *See block diagram.*

The electronic counter circuits are unusually stable, are independent of signal level, tube characteristics and tube

voltages, and require no adjustment except at long intervals. To check the accuracy of the counter circuits, a crystal-controlled oscillator at 200 kc is provided. This check is operated by a front-panel switch, and is usually only required at one-week intervals.

The *-hp-* 335B includes provision for operation of a remote modulation meter, as well as a remote peak modulation indicator lamp. The percentage modulation at which the lamp flashes a warning is adjusted on the front panel.

An audio output signal, provided for measurement purposes, has residual distortion of less than 0.25%, and the noise level is at least 75 db below 100% modulation at low frequencies. Frequency response is flat within 0.5 db of standard de-emphasis curve, 20 cps to 20 kc. A demodulated signal for remote or local aural monitoring is also provided at a 1 VU level.

Simple to install, compact in size, this new *-hp-* FM monitor can be supplied in a cabinet, or for relay rack mounting. Construction throughout is in accordance with engineering practices proven satisfactory for broadcast equipment. Components are rigidly mounted on bakelite cards; bathtub, mica and oil-filled condensers are used when voltages exceed 50.

SPECIFICATIONS

FREQUENCY MONITOR

Frequency Range: Any frequency, 88 mc to 108 mc. Supplied with crystal of frequency matching customer's transmitter.

Deviation Range: +3 kc to -3 kc mean frequency deviation.

Accuracy: Deviation indicator accuracy better than ± 1000 cps. ($\pm .001\%$.)

Power Required: Approximately 2 watts. Operates satisfactorily at levels above and below 2 watts.

MODULATION METER

Modulation Range: Meter reads full scale on modulation swing of 100 kc. Scale calibrated to 100% at 75 kc; 133% at 100 kc.

Accuracy: Within 5% modulation percentage over entire scale.

Meter Characteristics: Meter damped in accordance F.C.C. requirements. Reads peak value of modulation peak of duration between 40 and 90 milliseconds. Meter returns from full reading to 10% of full value within 500 to 800 milliseconds.

Frequency Response: Flat within $\pm 1/2$ db from 50 to 15,000 cps.

External Meters: Provision is made for installation of remote meter having full scale sensitivity of 400 microamperes. Scale should indicate 100% modulation at 300 microamperes. Extra meters can be supplied with unit.

PEAK LIMIT INDICATOR

Peak Limit Range: From 50% to 120% modulation (75 kc = 100%). Provision for external peak limit indicators.

AUDIO OUTPUT

Frequency Range: 20 cps to 20 kc. Response flat within $\pm 1/2$ db. Equipped with standard 75 microsecond de-emphasis circuit.

Distortion: Less than 0.25% at 100% modulation.

Output Voltage: 10 volts into 20,000 ohms, at low frequencies. (At 100% modulation.)

Noise: At least 75 db below audio output level resulting from 100% modulation at low frequencies.

Monitoring Output: 1.0 mw into 600 ohms, balanced, at 100% modulation. (At low frequencies.)

Size: Front panel 10 1/2" x 19". 13" deep.

Power: 115 volts 50/60 cps primary power. Requires approximately 150 watts.

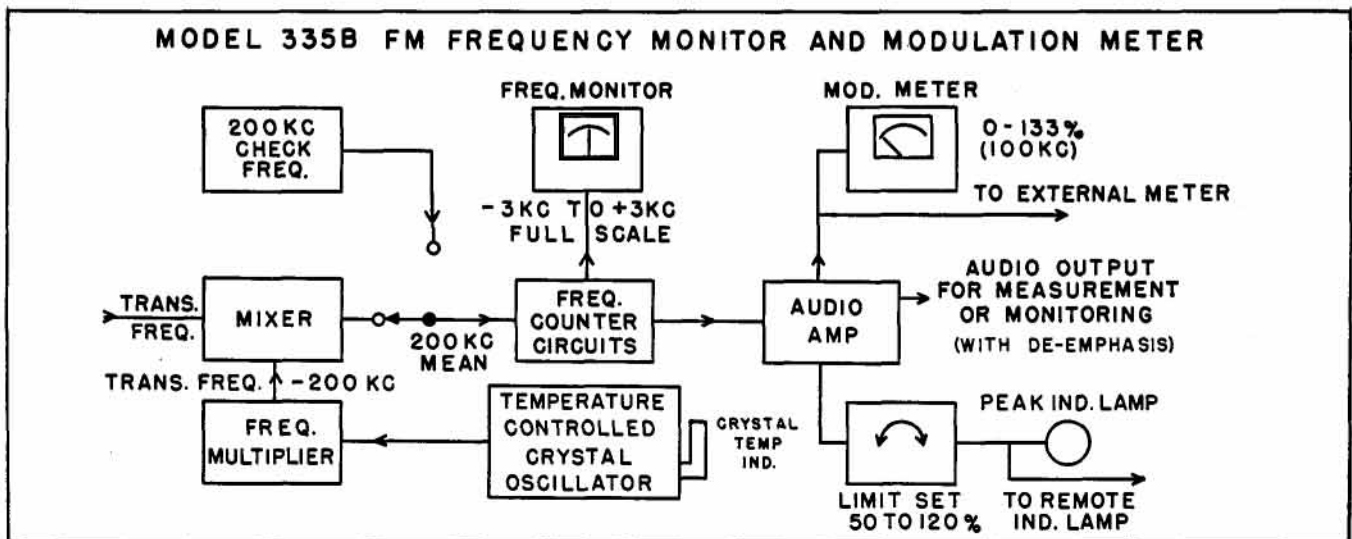

MODEL 455A

PROBE "T" CONNECTOR

The *-hp-* 455A Probe "T" Connector is designed to facilitate use of the *-hp-* 410A Vacuum Tube Voltmeter in UHF measurements. It is used to connect the diode probe of the voltmeter across a 50 ohm coaxial transmission line, and permits reading of voltages between central conductor and sheath.

Insertion of the *-hp-* 455A "T" Connector in a 50 ohm transmission line introduces a minimum discontinuity. Maximum standing wave ratios are 1 to 1.1 at 500 mc; 1 to 1.2 at 1000 mc.

The connector is provided with Type "N" fittings: Male connector No. UG 21/U; Female connector No. UG 23/U.

The connector contains a mica blocking capacitor for operation in connection with the *-hp-* 410A diode probe when probe's nose is removed. Construction is of silver plated brass. Polystyrene insulation throughout.

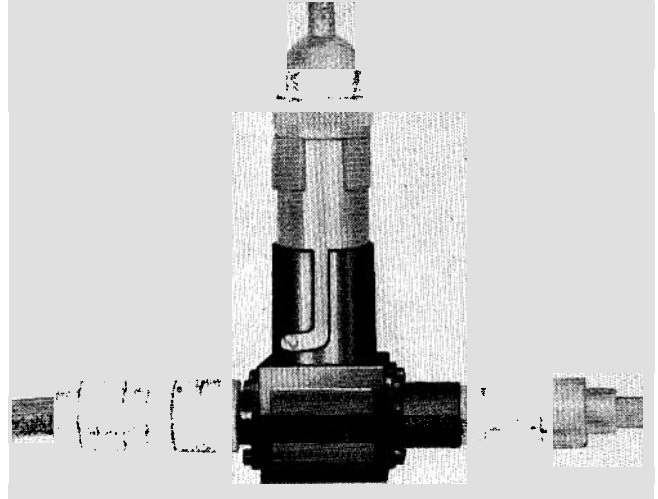

MODEL 458A TYPE "N" CONNECTOR

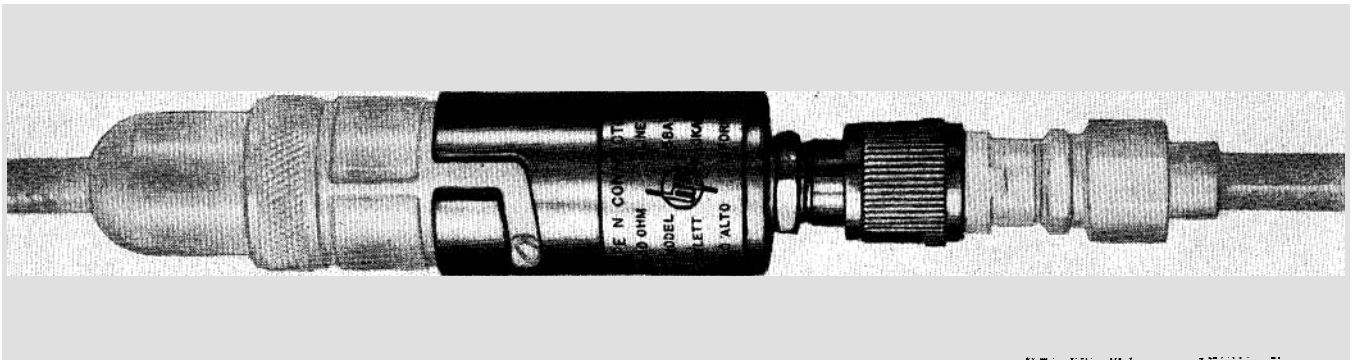

The *-hp-* 458A Type "N" Connector is designed for use with the *-hp-* 410A Vacuum Tube Voltmeter. It is used to connect the special diode probe of the *-hp-* 410A Voltmeter to the open end of a 50 ohm coaxial transmission line. (No terminating resistor is included.)

The *-hp-* 458A Connector uses Type "N" fitting No. UG 21/U. It contains a blocking capacitor to couple probe to the end of the transmission line, when the probe nose is removed.

The connector is bright silver plated brass, polystyrene insulated throughout.



SUGGESTIONS FOR ORDERING

Order by Model Number ... Always order by catalog model number and name of instrument desired. For example, "Model 206A Audio Signal Generator." Whenever possible mention frequency range or other significant specifications to prevent misunderstanding. Also mention features such as special color, special frequency range, non-standard power line voltage, etc., and whether cabinet or rack mounting style is desired.

Most Hewlett-Packard instruments are available in either cabinet or rack mounting. The letter "R" after the model number indicates rack mounting. For example, "206AR". An additional charge of \$5.00 is made for most rack mounting style instruments.

Orders should be sent direct to the factory and addressed to Hewlett-Packard Company, 395 Page Mill Road, Palo Alto, California. All orders are subject to final acceptance by the Hewlett-Packard Company.

Shipments ... Unless specifically requested otherwise, shipments are made by express. This policy is born of experience. Delicate instruments require the careful handling received in express shipment, and over a long period of time this method has proved most satisfactory. On request, shipments will be made by air freight or by truck. We do not recommend shipment by parcel post or by freight, and shipments will not be made by this type of carrier without specific instructions from the customer and the understanding that safe arrival is his entire risk.

Terms ... 30 days net. Unless credit has already been established, shipments will be made c.o.d. All prices are quoted f.o.b. Palo Alto.

Sales Representatives ... Sales representatives are maintained in principal cities as a service to our customers. Customers are invited to contact the nearest representatives at any time. They will gladly supply technical information, help prepare your order and, if desired, forward order to the factory. Orders should be made out to the Hewlett-Packard Company and are subject to final acceptance by the Company in Palo Alto. Sales representatives and their addresses are shown in the price list. Export sales are made through Frazar and Hansen, Ltd., 301 Clay Street, San Francisco 11, California.

Repairs ... When returning instruments for repairs, recalibration, or any other reason, please contact the Hewlett-Packard Company for shipping instructions. Give model number, type number, and serial number and as much information as possible concerning reason for return.

Repairs are made by the Hewlett-Packard Company at actual cost of labor and materials. Customers are invited to make full use of this service to insure maximum benefit from their instruments.

Repair Parts ... When ordering repair parts please describe carefully parts required. Give model number, type number, serial number of the instrument and date of original purchase. Identify parts on the wiring diagram if possible, giving date shown on the circuit wiring diagram.

WARRANTY

Hewlett-Packard Company warrants each instrument of its manufacture to be free from defects in material and workmanship. Our obligation under this Warranty is limited to servicing or adjusting any instrument returned to our factory for that purpose, and to making good at our factory any part or parts thereof except tubes, fuses or batteries which shall, within one year after making delivery to the original purchaser, be returned to us with transportation charges prepaid, and which on our examination shall disclose to our satisfaction to have been thus defective.

Hewlett-Packard reserves the right to make changes in design at any time without incurring any obligation to install same on units previously purchased.

This Warranty is expressly in lieu of all other obligations or liabilities on the part of Hewlett-Packard, and Hewlett-Packard neither assumes nor authorizes any other person to assume for them any other liability in connection with the sales of Hewlett-Packard instruments.